

# DENTAL HOSES

---

 <b>CEFLA</b>	<u>P. 2</u>
 <b>OPEN END TURBINE</b>	<u>P.16</u>
 <b>OPEN END MICROMOTOR</b>	<u>P.21</u>
 <b>OPEN END SCALER</b>	<u>P.31</u>
 <b>KAVO</b>	<u>P.35</u>
 <b>PLANMECA</b>	<u>P.47</u>
 <b>SIRONA</b>	<u>P.56</u>

# CEFLA DENTAL HOSES

The dental hoses for Tecnomed Italia dental units are made of silicone; they are Latex Free and comply with the UNI CEI EN ISO 13485 quality system.

The chemically stable gold-plated contacts ensure high electrical conductivity and maximum handpiece performance.

The supply tubes comply with REGULATION (EU) No. 10/2011 concerning plastic materials objects intended to meet food products and the exhaust tubes are resistant to the lubrication oils.

Tecnomed Italia dental hoses meet the strictest medical standards, complying with the essential requirements of the European Directives (93/42 / EEC) 2007/47 / EC on medical devices and 2000/95 / EC RoHs on the restriction of the use of certain specific substances in electrical and electronic equipment.

A complete range of dental hoses:

- Turbines
- Micromotors
- Scalers
- Syringes
- Freely Adaptable Dental Hoses





## Features

- ⊕ High quality silicone sheath.
- ⊕ Latex free.
- ⊕ 12 months warranty



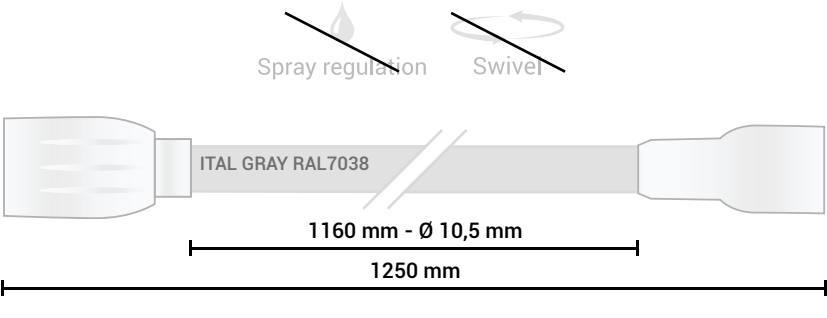

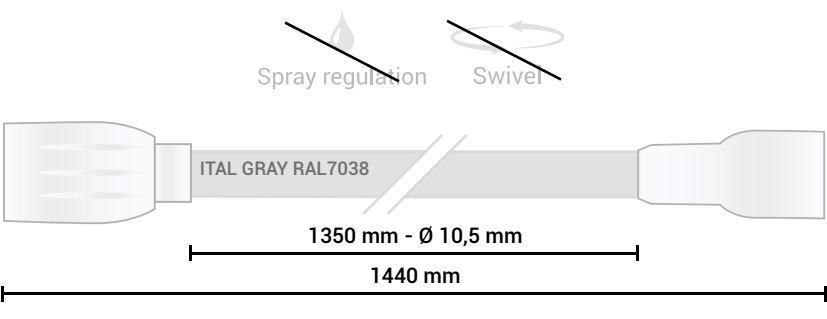

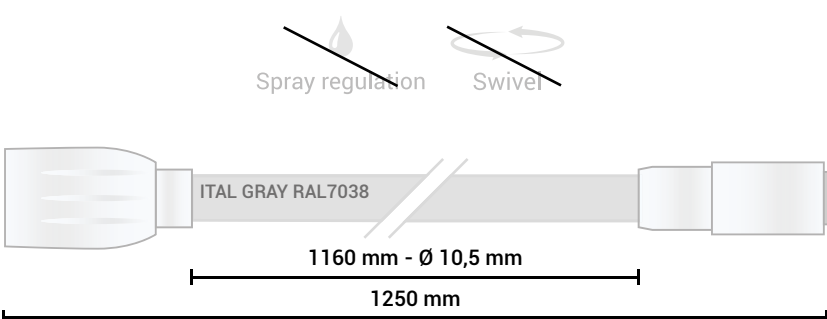
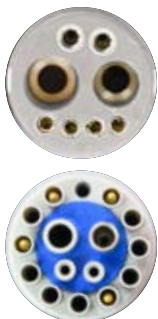
## Technical data

- ⊕ Maximum pressure supply/return air 4,5 bar / 65 psi
- ⊕ Maximum pressure air/water spray 4 bar / 58 psi
- ⊕ Tensile strenght 70N

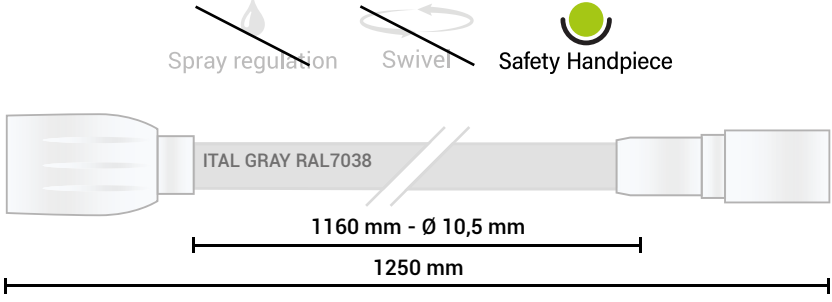

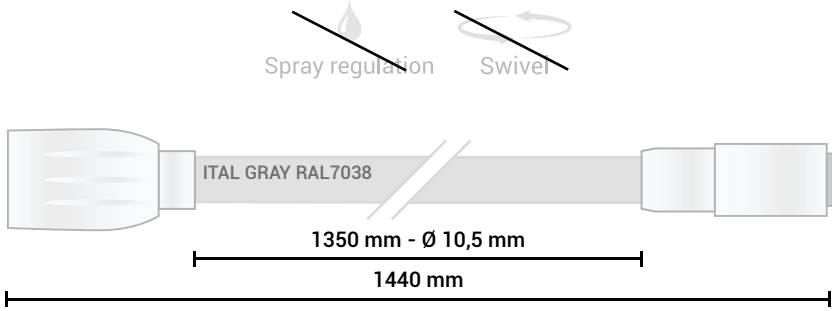
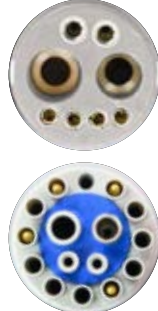

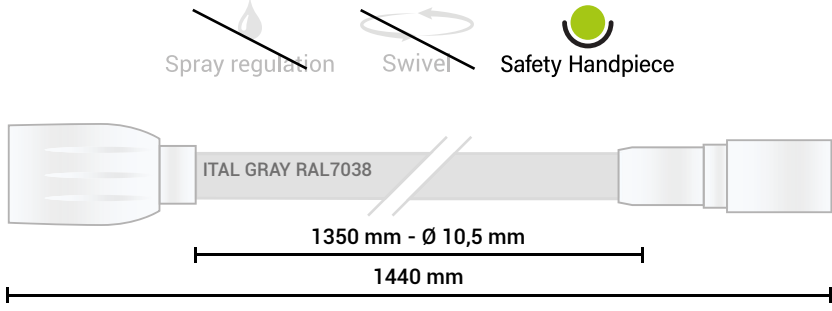

# MICROMOTORS TYPE

HANDPIECE TYPE	DENTAL UNIT MODEL	IMAGE	LENGHT / DIAMETER / COLOR	CONNECTIONS	ORDER CODE
MICROMOTOR MC2	ANTHOS A3, 5, 6, 7, 9/+ L6, 7, 9  STERN S200, 220, 250, 280, 300, 320, 380  CASTELLINI SKEMA 5, 6, 8 PUMA ELI				PC707CF
MICROMOTOR MC2	ANTHOS A3, 5, 6, 7, 9/+ L6, 7, 9  STERN S200, 220, 250, 280, 300, 320, 380  CASTELLINI SKEMA 5, 6, 8 PUMA ELI				PC709CF
MICROMOTOR MC3 M40	ANTHOS A3, 5, 6, 7, 9/+ L6, 7, 9  STERN S200, 220, 250, 280, 300, 320, 380  CASTELLINI SKEMA 5, 6, 8 PUMA ELI				PC710CF

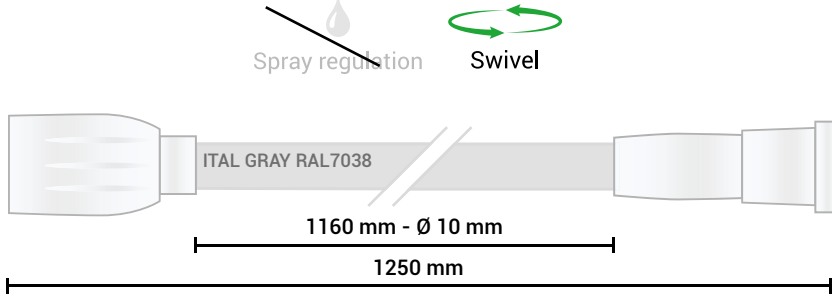

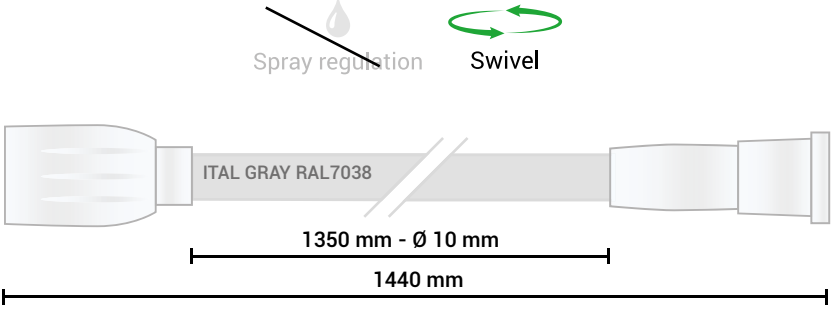
# MICROMOTORS TYPE

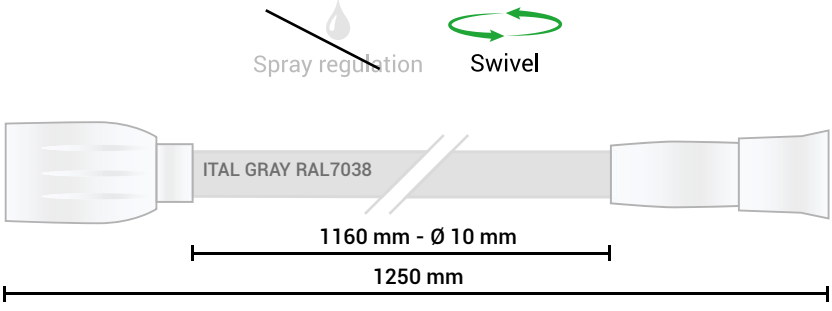
HANDPIECE TYPE	DENTAL UNIT MODEL	IMAGE	LENGHT / DIAMETER / COLOR	CONNECTIONS	ORDER CODE
MICROMOTOR  MC3 M40	ANTHOS A3, 5, 6, 7, 9/+ L6, 7, 9  STERN S200, 220, 250, 280, 300, 320, 380  CASTELLINI SKEMA 5, 6, 8 PUMA ELI		 <p>Spray regulation Swivel Safety Handpiece</p> <p>ITAL GRAY RAL7038</p> <p>1160 mm - Ø 10,5 mm</p> <p>1250 mm</p>		PC710CFSH
MICROMOTOR  MC3 M40	ANTHOS A3, 5, 6, 7, 9/+ L6, 7, 9  STERN S200, 220, 250, 280, 300, 320, 380  CASTELLINI SKEMA 5, 6, 8 PUMA ELI		 <p>Spray regulation Swivel</p> <p>ITAL GRAY RAL7038</p> <p>1350 mm - Ø 10,5 mm</p> <p>1440 mm</p>		PC712CF
MICROMOTOR  MC3 M40	ANTHOS A3, 5, 6, 7, 9/+ L6, 7, 9  STERN S200, 220, 250, 280, 300, 320, 380  CASTELLINI SKEMA 5, 6, 8 PUMA ELI		 <p>Spray regulation Swivel Safety Handpiece</p> <p>ITAL GRAY RAL7038</p> <p>1350 mm - Ø 10,5 mm</p> <p>1440 mm</p>		PC712CFSH







# MICROMOTORS TYPE

HANDPIECE TYPE	DENTAL UNIT MODEL	IMAGE	LENGHT / DIAMETER / COLOR	CONNECTIONS	ORDER CODE
MICROMOTOR <b>iXR3L iMMrL</b>	ANTHOS A3, 5/+, 6/+, 7+, 9, L6, 9, R7  STERN S200, 250, 280TRc, 380TRc, 300, 220TR, 230TR  CASTELLINI SKEMA 5, 6, 8				<b>PC733CX3</b>
MICROMOTOR <b>iXR3L iMMrL</b>	ANTHOS A3, 5/+, 6/+, 7+, 9, L6, 9, R7  STERN S200, 250, 280TRc, 380TRc, 300, 220TR, 230TR  CASTELLINI SKEMA 5, 6, 8				<b>PC733CX3L</b>
MICROMOTOR <b>iXS4 iMMs</b>	ANTHOS A7+ L9, R7  STERN S320TR, 280TRC, 300, 380TRC  CASTELLINI SKEMA 5, 6, 8				<b>PC744CX4</b> BEFORE 2016  <b>PC744CX4N</b> SINCE 2016

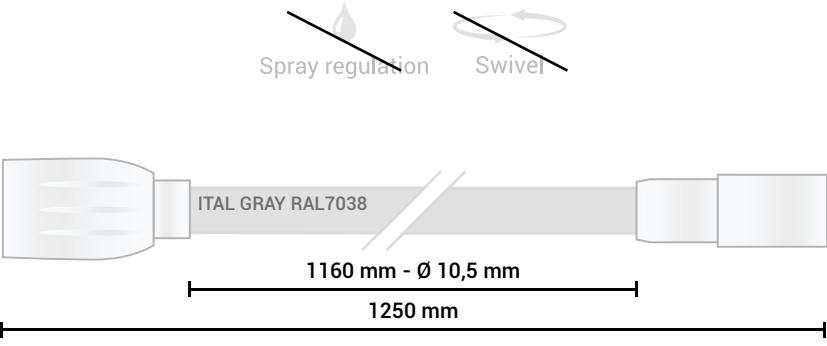

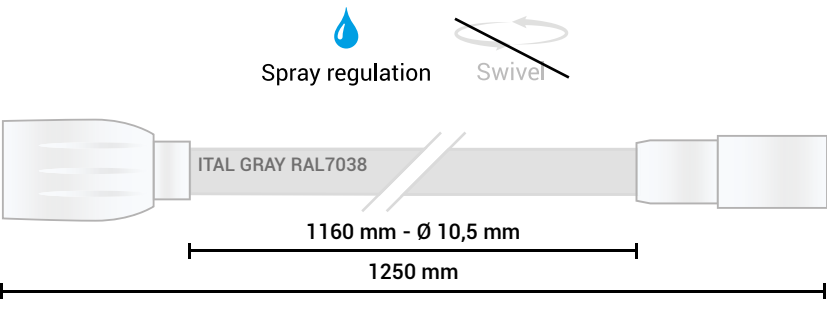

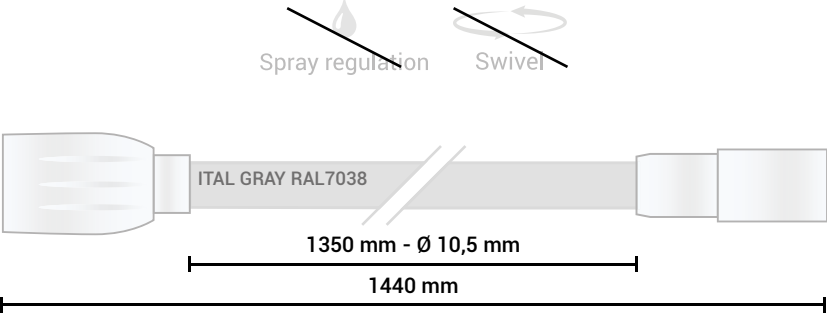
# MICROMOTORS TYPE

HANDPIECE TYPE	DENTAL UNIT MODEL	IMAGE	LENGHT / DIAMETER / COLOR	CONNECTIONS	ORDER CODE
MICROMOTOR  iXS4 iMMs	ANTHOS A7+ L9, R7		<p>Spray regulation Swivel</p> <p>ITAL GRAY RAL7038</p> <p>1350 mm - Ø 10 mm</p> <p>1440 mm</p>		PC744CX4L BEFORE 2016
	STERN S320TR, 280TRC, 300, 380TRC				CASTELLINI SKEMA 5, 6, 8



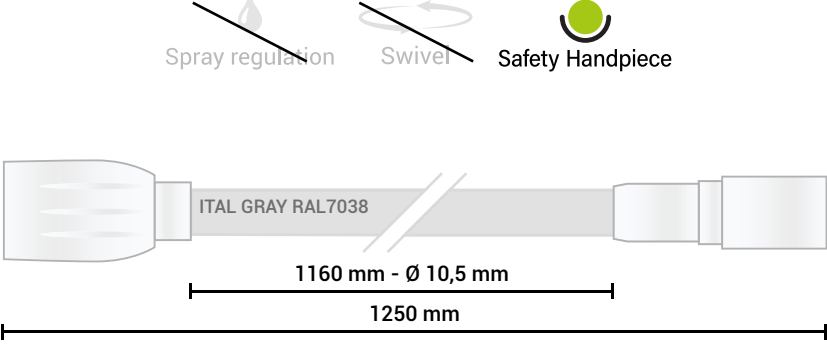

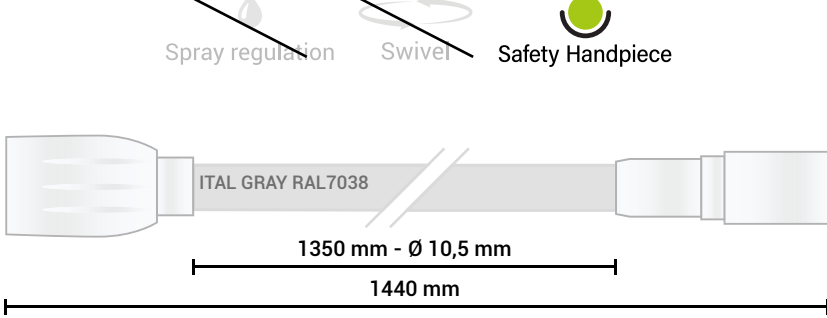

# HIGHSPEED TYPE

HANDPIECE TYPE	DENTAL UNIT MODEL	IMAGE	LENGHT / DIAMETER / COLOR	CONNECTIONS	ORDER CODE
HIGHSPEED HSH	ANTHOS A3, 5, 6, 7, 9/+ L6, 7, 9  STERN S200, 220, 250, 280, 300, 320, 380  CASTELLINI SKEMA 5, 6, 8 PUMA ELI				PC704CF
HIGHSPEED HSH	SKEMA 4 DUO				PC704CFW
HIGHSPEED HSH	ANTHOS A3, 5, 6, 7, 9/+ L6, 7, 9  STERN S200, 220, 250, 280, 300, 320, 380  CASTELLINI SKEMA 5, 6, 8 PUMA ELI				PC706CF

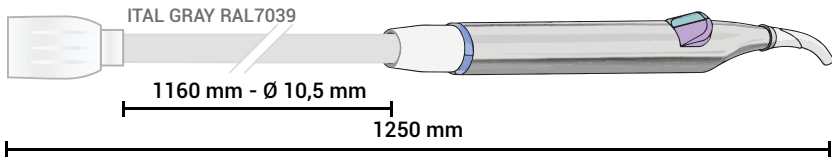

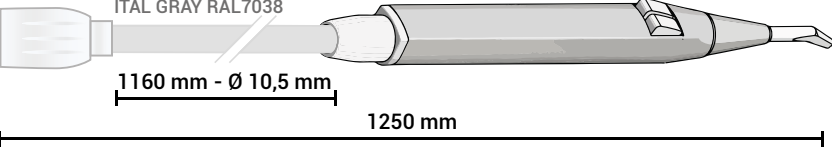

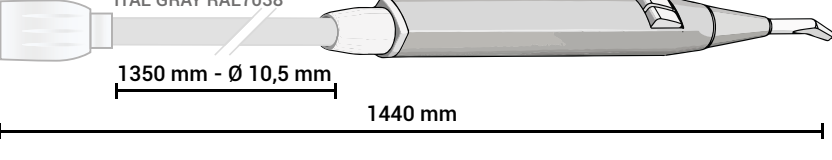

# HIGHSPEED TYPE

HANDPIECE TYPE	DENTAL UNIT MODEL	IMAGE	LENGHT / DIAMETER / COLOR	CONNECTIONS	ORDER CODE
HIGHSPEED HSH	ANTHOS A3, 5, 6, 7, 9/+ L6, 7, 9				PC704CFSH
	STERN S200, 220, 250, 280, 300, 320, 380				
HIGHSPEED HSH	ANTHOS A3, 5, 6, 7, 9/+ L6, 7, 9				PC706CFSH
	STERN S200, 220, 250, 280, 300, 320, 380				

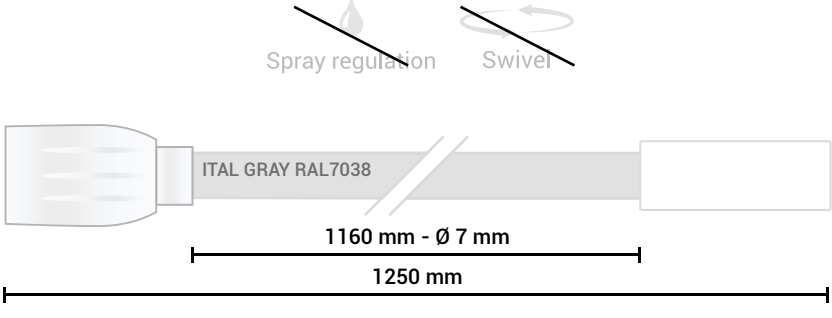

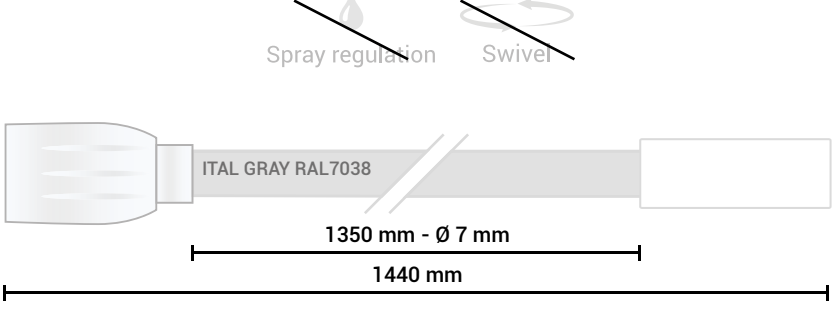

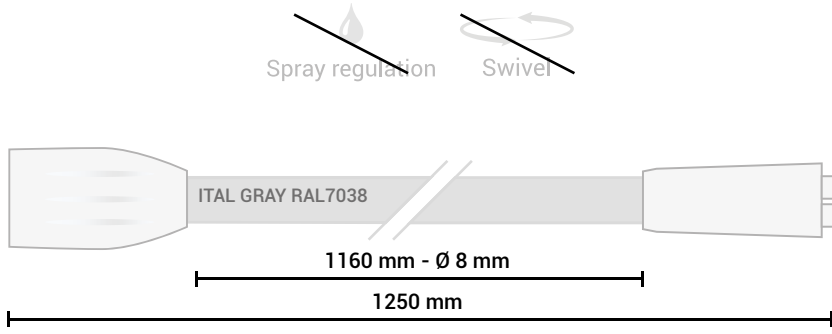

# SYRINGE TYPE

HANDPIECE TYPE	DENTAL UNIT MODEL	IMAGE	LENGHT / DIAMETER / COLOR	CONNECTIONS	ORDER CODE
<p>SYRINGE</p> <p>6F LUZZANI O.F. MINIBRIGHT INOX</p>	<p>ANTHOS A3, 5, 6, 7, 9/+ L6, 7, 9</p> <p>STERN S200, 220, 250, 280, 300, 320, 380</p> <p>CASTELLINI SKEMA 5, 6, 8 PUMA ELI</p>				<p>PC714EL</p>
<p>SYRINGE</p> <p>3F LUZZANI MINILIGHT INOX</p>	<p>ANTHOS A3, 5, 6, 7, 9/+ L6, 7, 9</p> <p>STERN S200, 220, 250, 280, 300, 320, 380</p> <p>CASTELLINI SKEMA 5, 6, 8 PUMA ELI</p>				<p>PC714C</p>
<p>SYRINGE</p> <p>3F LUZZANI MINILIGHT INOX</p>	<p>ANTHOS A3, 5, 6, 7, 9/+ L6, 7, 9</p> <p>STERN S200, 220, 250, 280, 300, 320, 380</p> <p>CASTELLINI SKEMA 5, 6, 8 PUMA ELI</p>				<p>PC714L</p>

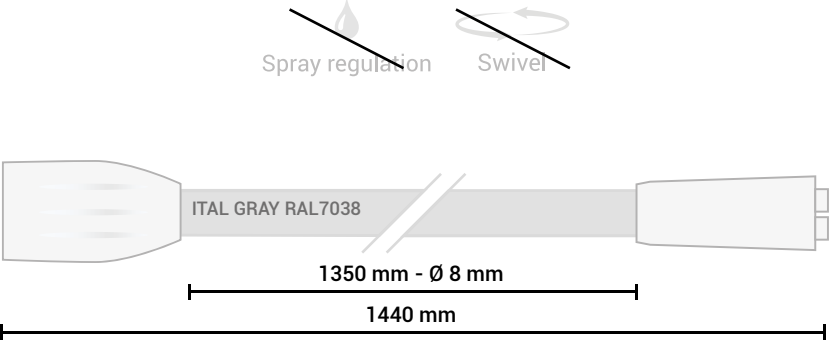

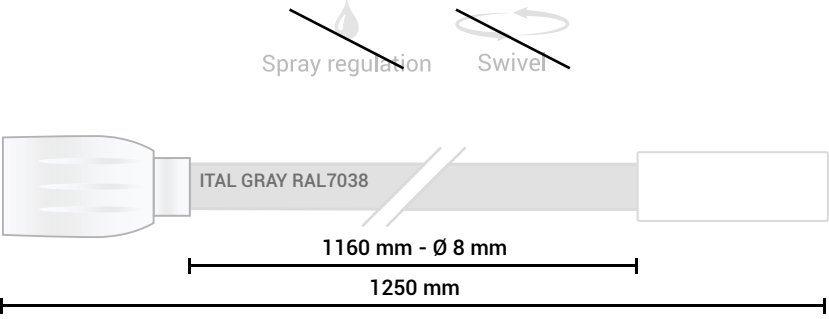

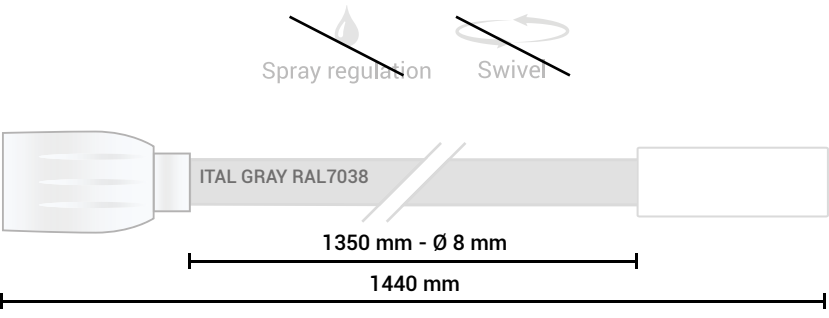

# SCALER TYPE

HANDPIECE TYPE	DENTAL UNIT MODEL	IMAGE	LENGHT / DIAMETER / COLOR	CONNECTIONS	ORDER CODE
SCALER EMS	ANTHOS A3, 5, 6, 7, 9/+ L6, 7, 9  STERN S200, 220, 250, 280, 300, 320, 380  CASTELLINI SKEMA 5, 6, 8 PUMA ELI				PC701CF
SCALER EMS	ANTHOS A3, 5, 6, 7, 9/+ L6, 7, 9  STERN S200, 220, 250, 280, 300, 320, 380  CASTELLINI SKEMA 5, 6, 8 PUMA ELI				PC703CF
SCALER PZ5	ANTHOS A3, 5, 6, 7, 9/+ L6, 7, 9  STERN S200, 220, 250, 280, 300, 320, 380  CASTELLINI SKEMA 5, 6, 8 PUMA ELI				PC701CP5

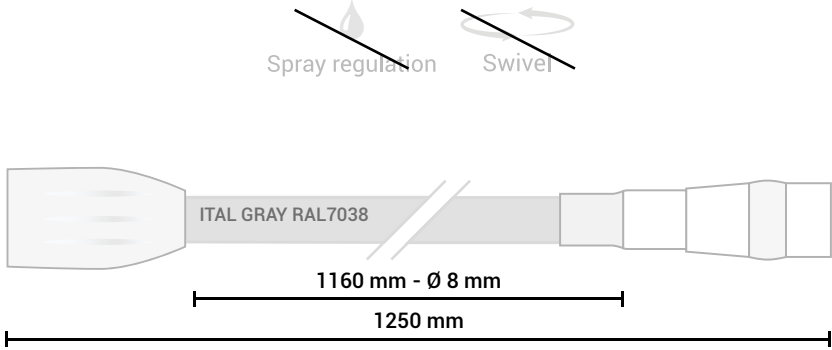

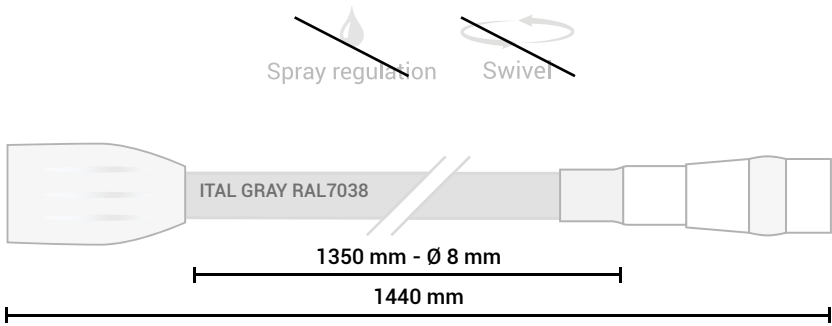

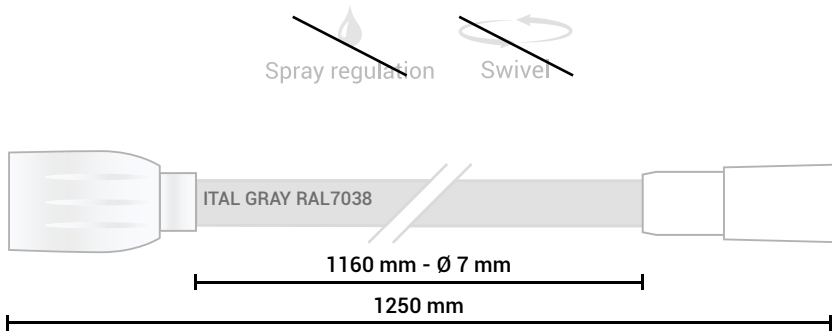

# SCALER TYPE

HANDPIECE TYPE	DENTAL UNIT MODEL	IMAGE	LENGHT / DIAMETER / COLOR	CONNECTIONS	ORDER CODE
SCALER PZ5	ANTHOS A3, 5, 6, 7, 9/+ L6, 7, 9  STERN S200, 220, 250, 280, 300, 320, 380  CASTELLINI SKEMA 5, 6, 8 PUMA ELI				PC701CP5F
SCALER EMS O. F.	ANTHOS A3, 5, 6, 7, 9/+ L6, 7, 9  STERN S200, 220, 250, 280, 300, 320, 380  CASTELLINI SKEMA 5, 6, 8 PUMA ELI				PC701CFE
SCALER EMS O. F.	ANTHOS A3, 5, 6, 7, 9/+ L6, 7, 9  STERN S200, 220, 250, 280, 300, 320, 380  CASTELLINI SKEMA 5, 6, 8 PUMA ELI				PC703CFEL

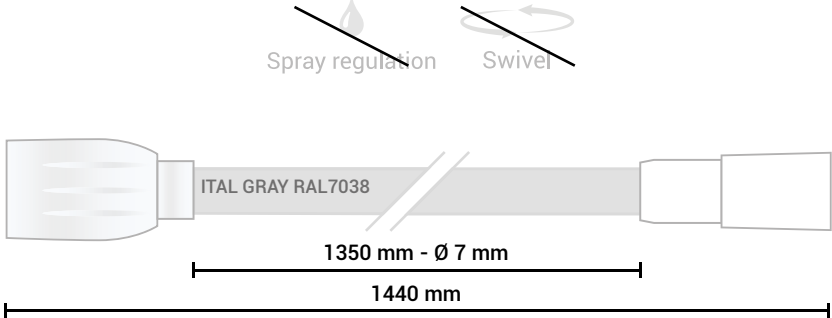

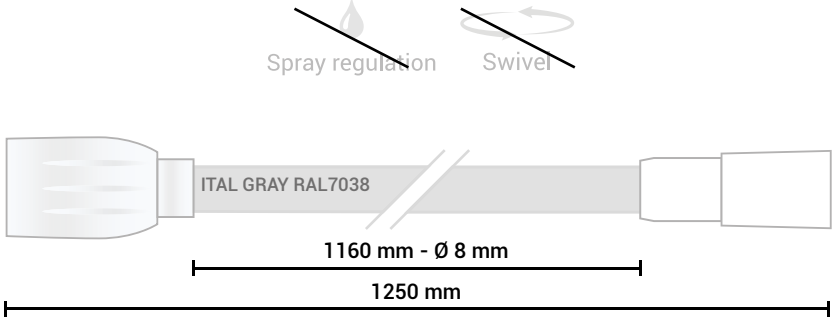

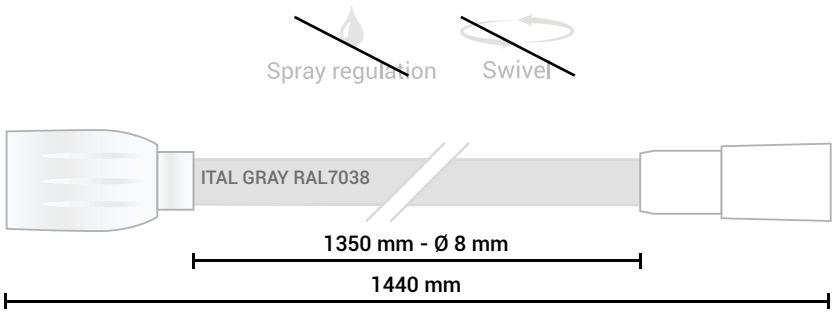

# SCALER TYPE

HANDPIECE TYPE	DENTAL UNIT MODEL	IMAGE	LENGHT / DIAMETER / COLOR	CONNECTIONS	ORDER CODE
SCALER PIEZOLIGHT 6 OLD PZ7-SCA3	ANTHOS A3, 5, 6, 7, 9/+ L6, 7, 9 STERN S200, 220, 250, 280, 300, 320, 380 CASTELLINI SKEMA 5, 6, 8 PUMA ELI				PC701CF4
SCALER PIEZOLIGHT 6 OLD PZ7-SCA3	ANTHOS A3, 5, 6, 7, 9/+ L6, 7, 9 STERN S200, 220, 250, 280, 300, 320, 380 CASTELLINI SKEMA 5, 6, 8 PUMA ELI				PC703CF4
SCALER SATELEC	ANTHOS A3, 5, 6, 7, 9/+ L6, 7, 9 STERN S200, 220, 250, 280, 300, 320, 380 CASTELLINI SKEMA 5, 6, 8 PUMA ELI				PC701CFS

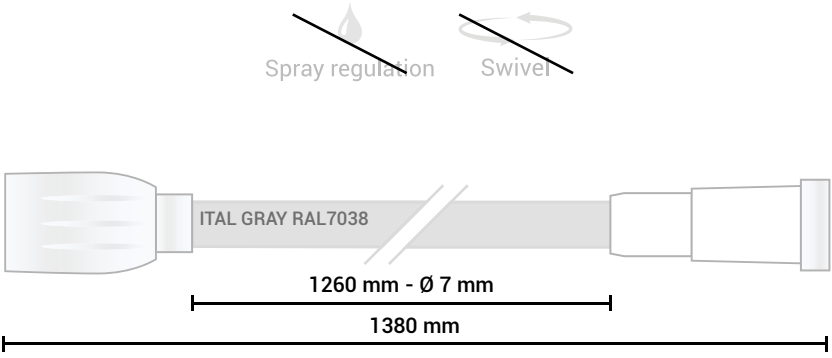

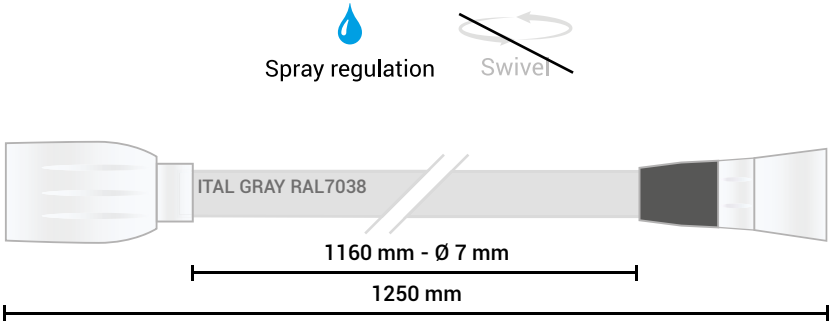

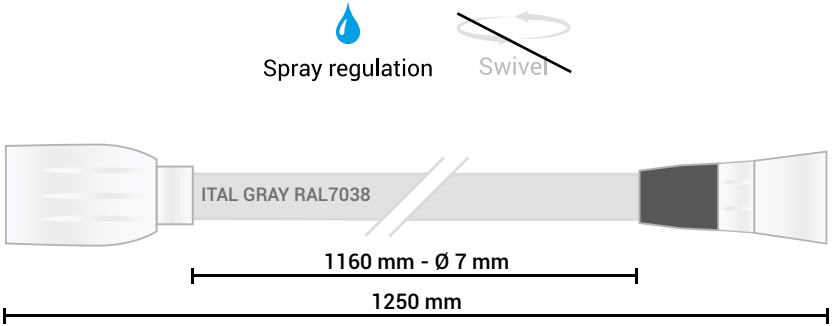



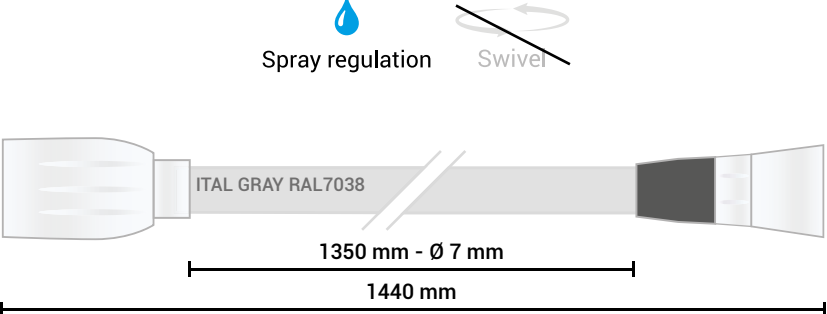

# SCALER TYPE

HANDPIECE TYPE	DENTAL UNIT MODEL	IMAGE	LENGHT / DIAMETER / COLOR	CONNECTIONS	ORDER CODE
SCALER SATELEC	ANTHOS A3, 5, 6, 7, 9/+ L6, 7, 9  STERN S200, 220, 250, 280, 300, 320, 380  CASTELLINI SKEMA 5, 6, 8 PUMA ELI				PC703CFS
SCALER SATELEC NEWTRON LED	ANTHOS A3, 5, 6, 7, 9/+ L6, 7, 9  STERN S200, 220, 250, 280, 300, 320, 380  CASTELLINI SKEMA 5, 6, 8 PUMA ELI				PC701CFSL
SCALER SATELEC NEWTRON LED	ANTHOS A3, 5, 6, 7, 9/+ L6, 7, 9  STERN S200, 220, 250, 280, 300, 320, 380  CASTELLINI SKEMA 5, 6, 8 PUMA ELI				PC703CFSL

# SCALER TYPE

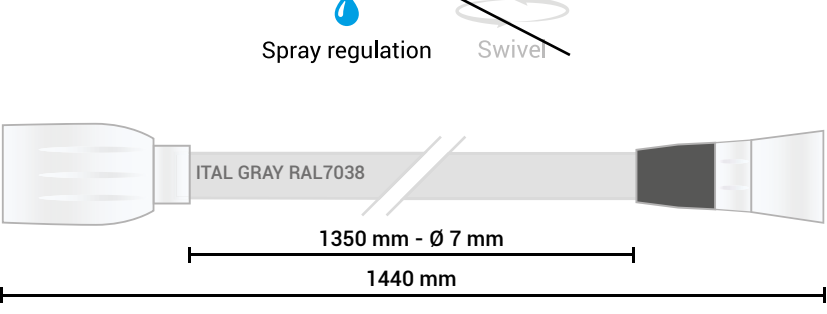
HANDPIECE TYPE	DENTAL UNIT MODEL	IMAGE	LENGHT / DIAMETER / COLOR	CONNECTIONS	ORDER CODE
SCALER PIEZOSTERIL 5 SURGISON	ANTHOS A3, 5, 6, 7, 9/+ L6, 7, 9  STERN S200, 220, 250, 280, 300, 320, 380  CASTELLINI SKEMA 5, 6, 8 PUMA ELI				PC705CPS
SCALER PIEZOLIGHT 6 PZ7-SCA3 NEW	ANTHOS A3, 5, 6, 7, 9/+ L6, 7, 9  STERN S200, 220, 250, 280, 300, 320, 380  CASTELLINI SKEMA 5, 6, 8 PUMA ELI				PC741C
SCALER PIEZOLIGHT 6 PZ7-SCA3 NEW	ANTHOS A3, 5, 6, 7, 9/+ L6, 7, 9  STERN S200, 220, 250, 280, 300, 320, 380  CASTELLINI SKEMA 5, 6, 8 PUMA ELI				PC741CL

# SCALER TYPE

HANDPIECE TYPE	DENTAL UNIT MODEL	IMAGE	LENGHT / DIAMETER / COLOR	CONNECTIONS	ORDER CODE
SCALER  PIEZOLIGHT 6 PZ7-SCA3 NEW	ANTHOS A3, 5, 6, 7, 9/+ L6, 7, 9  STERN S200, 220, 250, 280, 300, 320, 380  CASTELLINI SKEMA 5, 6, 8 PUMA ELI		 <p>Spray regulation  Swivel </p> <p>ITAL GRAY RAL7038</p> <p>1350 mm - Ø 7 mm</p> <p>1440 mm</p>	 	PC742C
SCALER  PIEZOLIGHT 6 PZ7-SCA3 NEW	ANTHOS A3, 5, 6, 7, 9/+ L6, 7, 9  STERN S200, 220, 250, 280, 300, 320, 380  CASTELLINI SKEMA 5, 6, 8 PUMA ELI		 <p>Spray regulation  Swivel </p> <p>ITAL GRAY RAL7038</p> <p>1350 mm - Ø 7 mm</p> <p>1440 mm</p>	 	PC742CL

# OPEN END TURBINE DENTAL HOSES

The dental hoses for Tecnomed Italia dental units are made of silicone; they are Latex Free and comply with the UNI CEI EN ISO 13485 quality system.

The chemically stable gold-plated contacts ensure high electrical conductivity and maximum handpiece performance.

The supply tubes comply with REGULATION (EU) No. 10/2011 concerning plastic materials objects intended to meet food products and the exhaust tubes are resistant to the lubrication oils.

Tecnomed Italia dental hoses meet the strictest medical standards, complying with the essential requirements of the European Directives (93/42 / EEC) 2007/47 / EC on medical devices and 2000/95 / EC RoHs on the restriction of the use of certain specific substances in electrical and electronic equipment.

A complete range of dental hoses:

- Turbines
- Micromotors
- Scalers
- Syringes
- Freely Adaptable Dental Hoses

## Features

- ⊕ High quality silicone sheath.
- ⊕ Latex free.
- ⊕ 12 months warranty

## Technical data

- ⊕ Maximum pressure supply/return air 4,5 bar / 65 psi
- ⊕ Maximum pressure air/water spray 4 bar / 58 psi
- ⊕ Tensile strenght 70N

# OPEN END CORDONS TURBINE

HANDPIECE TYPE	DENTAL UNIT MODEL	IMAGE	LENGHT / DIAMETER / COLOR	CONNECTIONS	ORDER CODE
HIGHSPEED LABORATORY HSH B2			<p>Spray regulation Swivel</p> <p>LIGHT GRAY RAL7035</p> <p>250/1000 mm</p>		PL042B
HIGHSPEED HSH B2/3			<p>Spray regulation Swivel</p> <p>EXTENSION STRING ITAL GRAY RAL7038</p> <p>1650 mm - Ø 10,5 mm</p>		PC334
HIGHSPEED HSH B2/3			<p>Spray regulation Swivel</p> <p>LIGHT GRAY RAL7035</p> <p>200/1000 mm</p>		PC534

# OPEN END CORDONS TURBINE

HANDPIECE TYPE	DENTAL UNIT MODEL	IMAGE	LENGHT / DIAMETER / COLOR	CONNECTIONS	ORDER CODE
HIGHSPEED HSH M4			<p>Spray regulation Swivel</p> <p>LIGHT GRAY RAL7035</p> <p>1500 mm - Ø 11 mm</p>		PC444
HIGHSPEED HSH M4			<p>Spray regulation Swivel</p> <p>LIGHT GRAY RAL7035</p> <p>200/1000 mm</p>		PC544
HIGHSPEED HSH M4 O.F.			<p>Spray regulation Swivel</p> <p>EXTENSION STRING</p> <p>LIGHT GRAY RAL7035</p> <p>1500 mm - Ø 11 mm</p>		PC655

# OPEN END CORDONS TURBINE

HANDPIECE TYPE	DENTAL UNIT MODEL	IMAGE	LENGHT / DIAMETER / COLOR	CONNECTIONS	ORDER CODE
HIGHSPEED HSH M4 O.F.			<p>Spray regulation Swivel</p> <p>EXTENSION STRING ITAL GRAY RAL7038</p> <p>1650 mm - Ø 10,5 mm</p>		PC655TK
HIGHSPEED HSH CASTELLINI OLD			<p>Spray regulation Swivel</p> <p>EXTENSION STRING WHITE RAL9010</p> <p>1650 mm - Ø 10,5 mm</p>		PC306C
HIGHSPEED HSH CASTELLINI OLD			<p>Spray regulation Swivel</p> <p>EXTENSION STRING ITAL GRAY RAL7038</p> <p>1650 mm - Ø 10,5 mm</p>		PC306C/2

# OPEN END CORDONS TURBINE

HANDPIECE TYPE	DENTAL UNIT MODEL	IMAGE	LENGHT / DIAMETER / COLOR	CONNECTIONS	ORDER CODE
HIGHSPEED HSH M4 O.F.			<p>Spray regulation Swivel Safety Handpiece</p> <p>EXTENSION STRING ITAL GRAY RAL7038</p> <p>1650 mm - Ø 10,5 mm</p>		PC655TKSH
HIGHSPEED HSH M4 O.F. MC3 M40			<p>Spray regulation Swivel</p> <p>EXTENSION STRING LIGHT GRAY RAL7035</p> <p>1500 mm - Ø 11 mm</p>		PC666TM

# OPEN END MICROMOTOR DENTAL HOSES

The dental hoses for Tecnomed Italia dental units are made of silicone; they are Latex Free and comply with the UNI CEI EN ISO 13485 quality system.

The chemically stable gold-plated contacts ensure high electrical conductivity and maximum handpiece performance.

The supply tubes comply with REGULATION (EU) No. 10/2011 concerning plastic materials objects intended to meet food products and the exhaust tubes are resistant to the lubrication oils.

Tecnomed Italia dental hoses meet the strictest medical standards, complying with the essential requirements of the European Directives (93/42 / EEC) 2007/47 / EC on medical devices and 2000/95 / EC RoHs on the restriction of the use of certain specific substances in electrical and electronic equipment.

A complete range of dental hoses:

- Turbines
- Micromotors
- Scalers
- Syringes
- Freely Adaptable Dental Hoses





## Features

- ⊕ High quality silicone sheath.
- ⊕ Latex free.
- ⊕ 12 months warranty

## Technical data

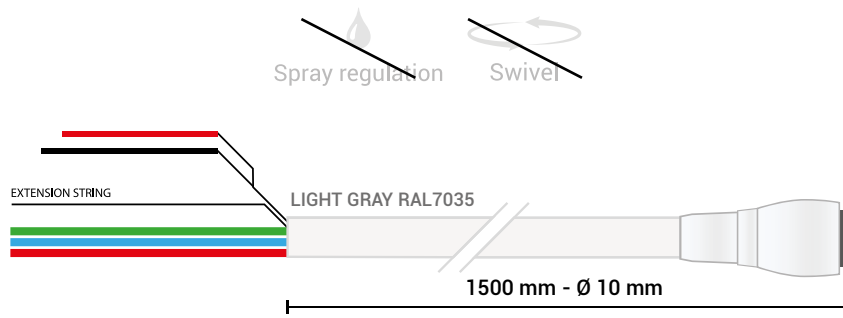
- ⊕ Maximum pressure supply/return air 4,5 bar / 65 psi
- ⊕ Maximum pressure air/water spray 4 bar / 58 psi
- ⊕ Tensile strenght 70N

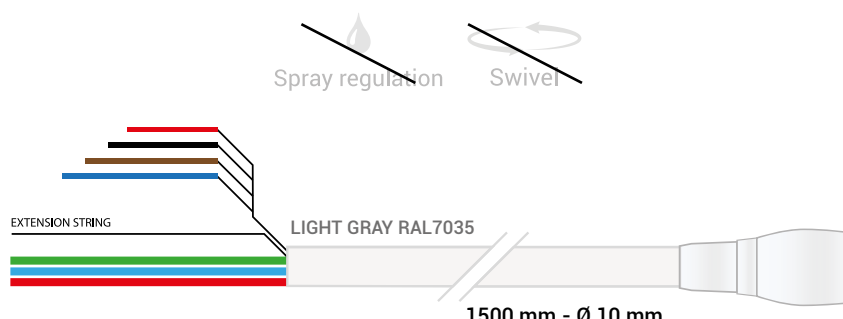
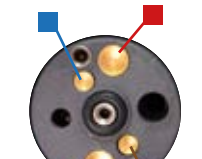
# BIEN AIR MICROMOTORS

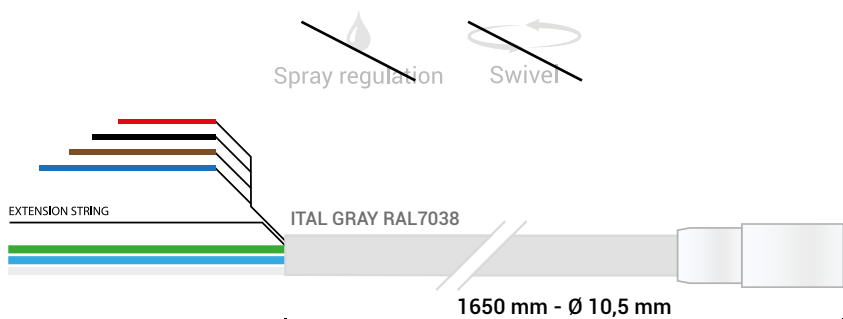
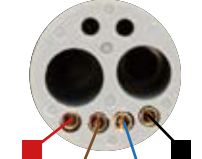
HANDPIECE TYPE	DENTAL UNIT MODEL	IMAGE	LENGHT / DIAMETER / COLOR	CONNECTIONS	ORDER CODE
MICROMOTOR MC2 (NO LUX)			 <p>Spray regulation Swivel</p> <p>EXTENSION STRING LIGHT GRAY RAL7035</p> <p>1500 mm - Ø 10 mm</p>		PC722
MICROMOTOR MC2			 <p>Spray regulation Swivel</p> <p>EXTENSION STRING LIGHT GRAY RAL7035</p> <p>1500 mm - Ø 10 mm</p>		PC732
MICROMOTOR MC3			 <p>Spray regulation Swivel</p> <p>EXTENSION STRING ITAL GRAY RAL7038</p> <p>1650 mm - Ø 10,5 mm</p>		PC666



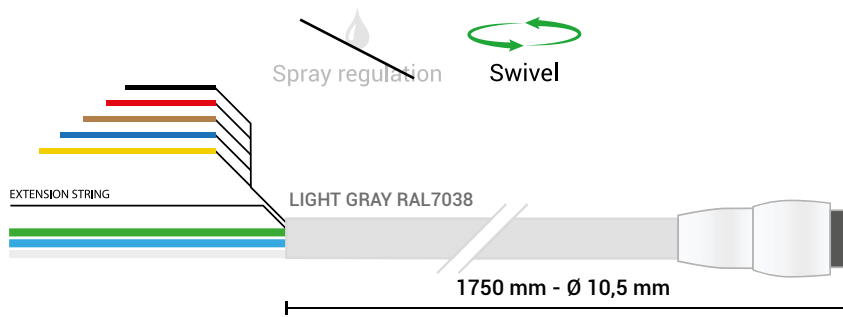
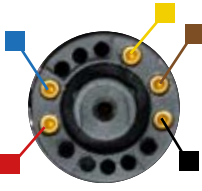

# BIEN AIR MICROMOTORS

HANDPIECE TYPE	DENTAL UNIT MODEL	IMAGE	LENGHT / DIAMETER / COLOR	CONNECTIONS	ORDER CODE
MICROMOTOR MC3 HSH			<p>Spray regulation Swivel</p> <p>EXTENSION STRING LIGHT GRAY RAL7035</p> <p>1500 mm - Ø 11 mm</p>		PC666TM
MICROMOTOR MC3			<p>Spray regulation Swivel Safety Handpiece</p> <p>EXTENSION STRING ITAL GRAY RAL7038</p> <p>1650 mm - Ø 10,5 mm</p>		PC666SH
MICROMOTOR MX2			<p>Spray regulation Swivel</p> <p>EXTENSION STRING ITAL GRAY RAL7038</p> <p>1500 mm - Ø 9,5 mm</p>		PC734BXG



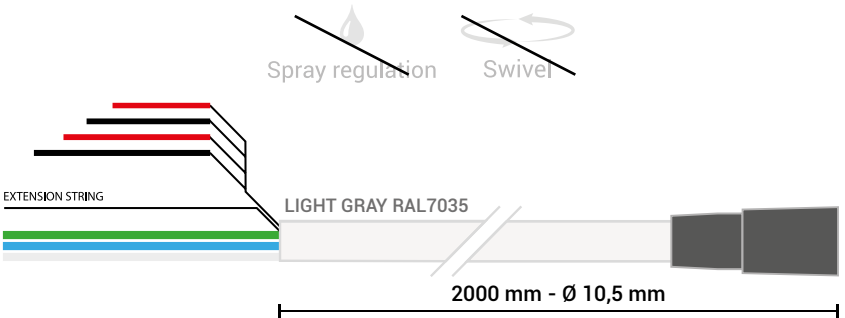
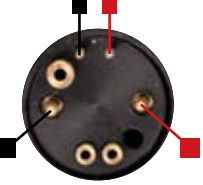

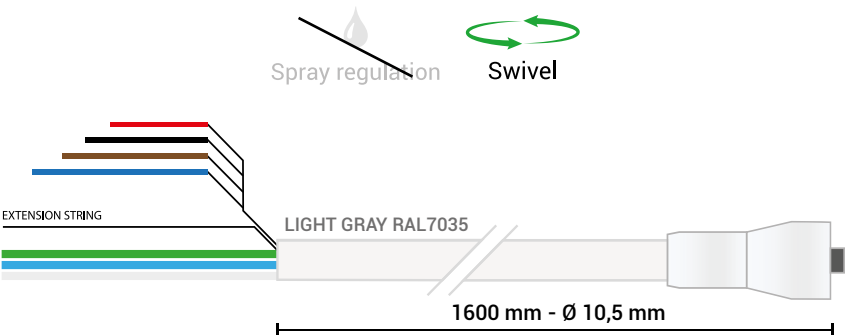
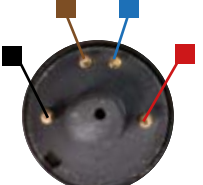
# BIEN AIR MICROMOTORS

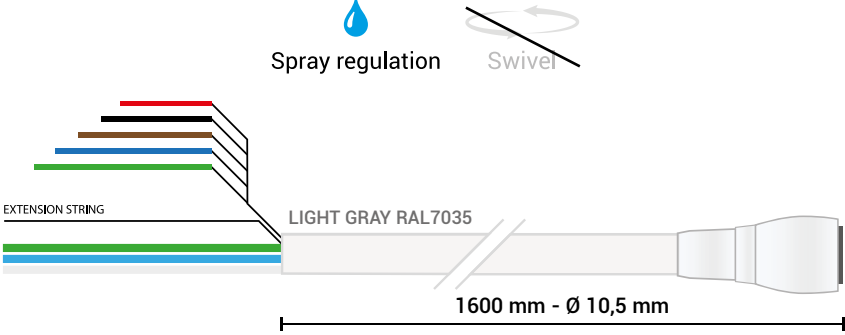
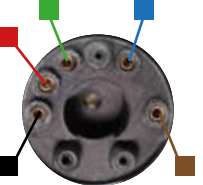
HANDPIECE TYPE	DENTAL UNIT MODEL	IMAGE	LENGHT / DIAMETER / COLOR	CONNECTIONS	ORDER CODE
MICROMOTOR  MCX			 <p>Spray regulation</p> <p>Swivel</p> <p>EXTENSION STRING</p> <p>LIGHT GRAY RAL7038</p> <p>1750 mm - Ø 10,5 mm</p>		PC735MCX



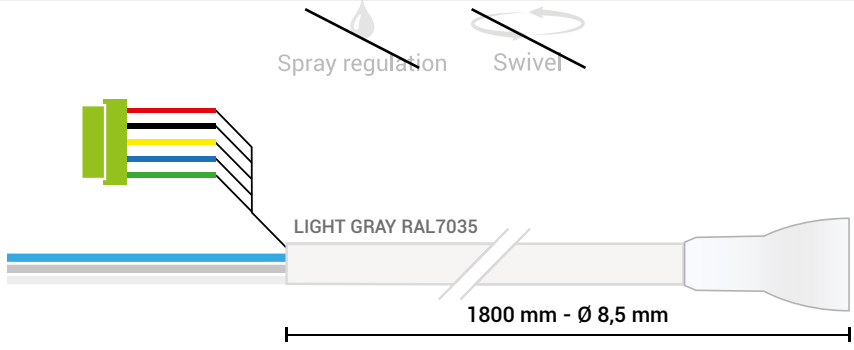
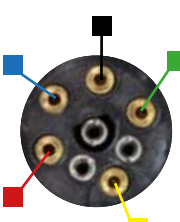

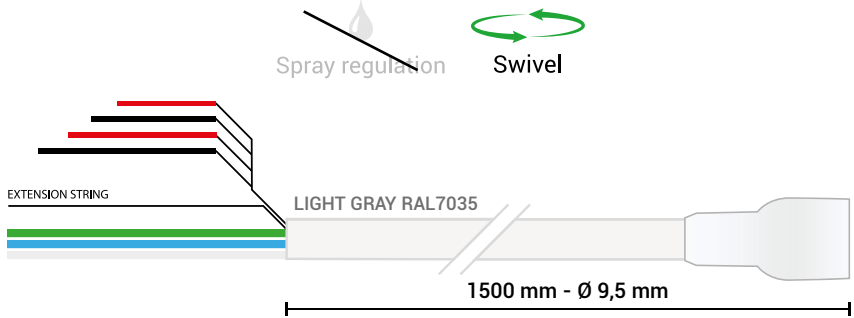
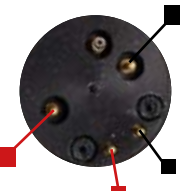

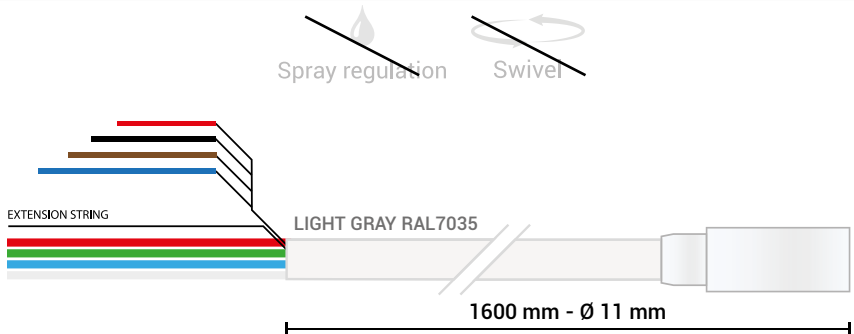
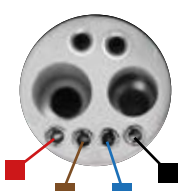
# KAVO MICROMOTORS

HANDPIECE TYPE	DENTAL UNIT MODEL	IMAGE	LENGHT / DIAMETER / COLOR	CONNECTIONS	ORDER CODE
MICROMOTOR K192			 <p>Spray regulation Swivel</p> <p>EXTENSION STRING</p> <p>LIGHT GRAY RAL7035</p> <p>2000 mm - Ø 10,5 mm</p>		PC124PKN
MICROMOTOR K190 K196 K201			 <p>Spray regulation Swivel</p> <p>EXTENSION STRING</p> <p>LIGHT GRAY RAL7035</p> <p>1600 mm - Ø 10,5 mm</p>		PC135PKN
MICROMOTOR K700 K701 K703			 <p>Spray regulation Swivel</p> <p>EXTENSION STRING</p> <p>LIGHT GRAY RAL7035</p> <p>1600 mm - Ø 10,5 mm</p>		PC148PKN

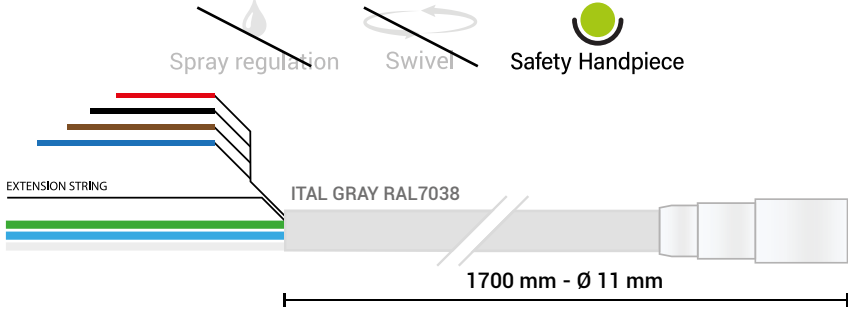
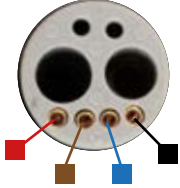
# NSK MICROMOTORS

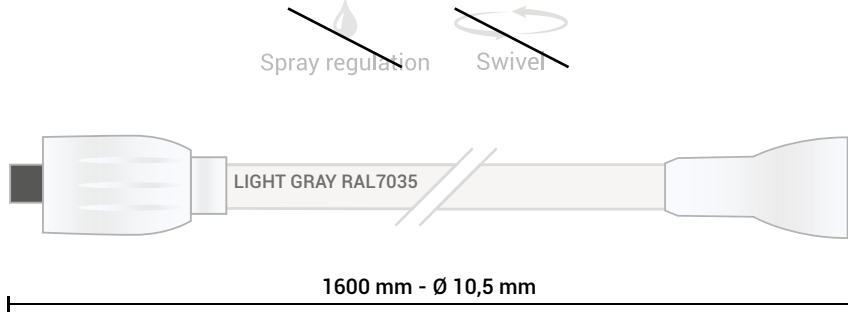
HANDPIECE TYPE	DENTAL UNIT MODEL	IMAGE	LENGHT / DIAMETER / COLOR	CONNECTIONS	ORDER CODE
MICROMOTOR NLX NANO - PLUS ADEC AE53-NLZ					PC601N
MICROMOTOR TIM 40 EL400					PC602N
MICROMOTOR M40 HSH					PC666TM

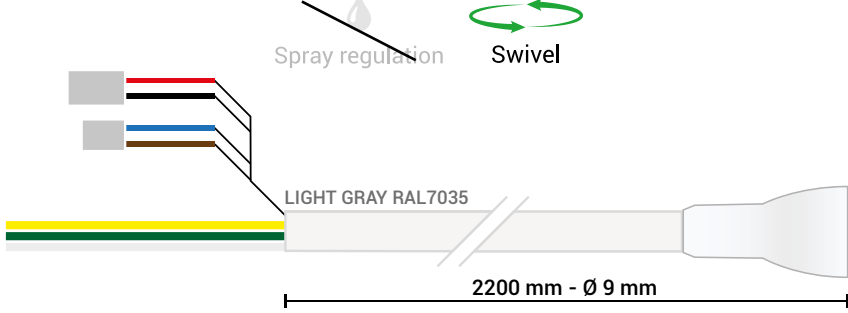
# NSK MICROMOTORS

HANDPIECE TYPE	DENTAL UNIT MODEL	IMAGE	LENGHT / DIAMETER / COLOR	CONNECTIONS	ORDER CODE
MICROMOTOR M40 HSH			 <p>ITAL GRAY RAL7038</p> <p>1700 mm - Ø 11 mm</p>		PC901NSH
MICROMOTOR NLX-NL400			 <p>LIGHT GRAY RAL7035</p> <p>1600 mm - Ø 10,5 mm</p>		PC603N
MICROMOTOR NBX			 <p>LIGHT GRAY RAL7035</p> <p>2200 mm - Ø 9 mm</p>		PC604N

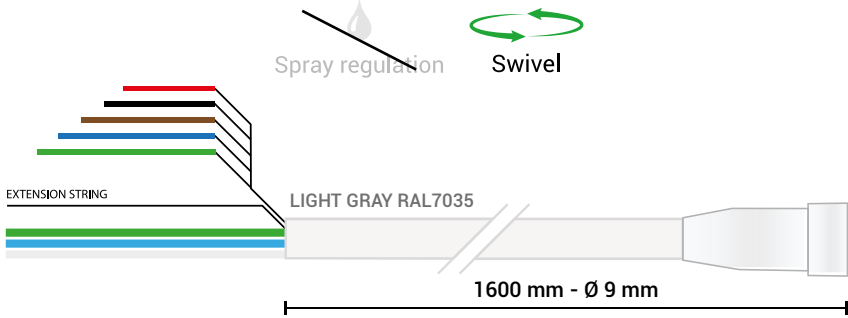
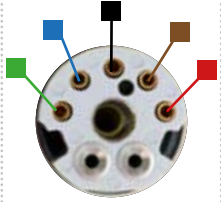

# FONA MICROMOTORS

HANDPIECE TYPE	DENTAL UNIT MODEL	IMAGE	LENGHT / DIAMETER / COLOR	CONNECTIONS	ORDER CODE
MICROMOTOR  BL			 <p>Spray regulation</p> <p>Swivel</p> <p>EXTENSION STRING</p> <p>LIGHT GRAY RAL7035</p> <p>1600 mm - Ø 9 mm</p>		PC233F

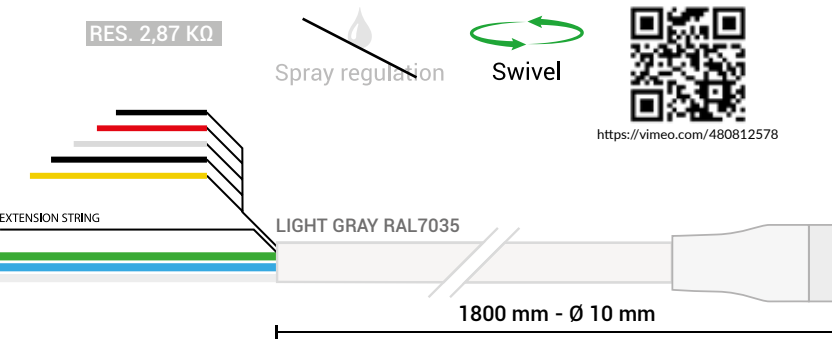
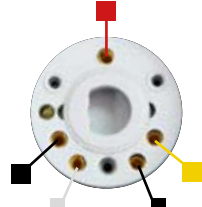
# PLANMECA MICROMOTORS

HANDPIECE TYPE	DENTAL UNIT MODEL	IMAGE	LENGHT / DIAMETER / COLOR	CONNECTIONS	ORDER CODE
MICROMOTOR  MINETTO					PC888P

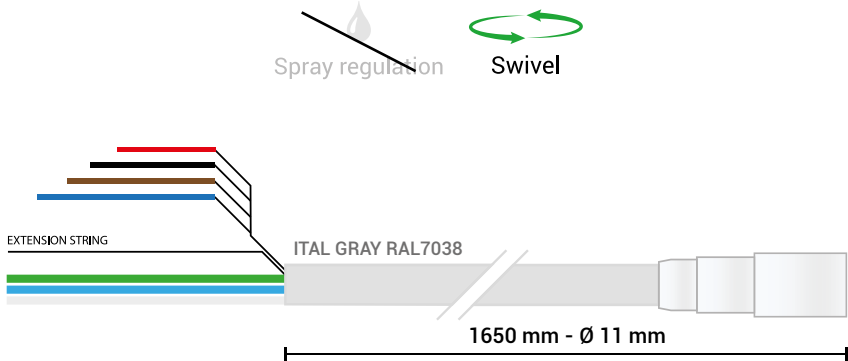
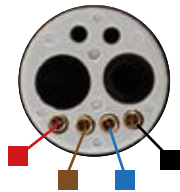
# TEKNEDENTAL MICROMOTORS

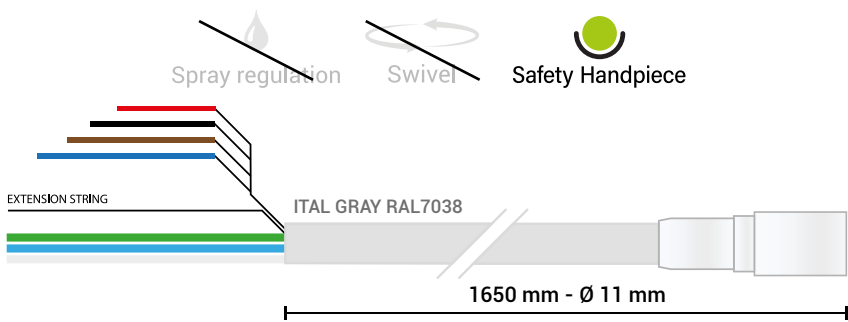
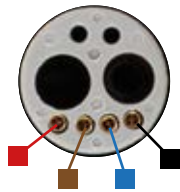
HANDPIECE TYPE	DENTAL UNIT MODEL	IMAGE	LENGHT / DIAMETER / COLOR	CONNECTIONS	ORDER CODE
MICROMOTOR TKD DEFINITIVE LED			 <p>Spray regulation Swivel</p> <p>EXTENSION STRING</p> <p>ITAL GRAY RAL7038</p> <p>1650 mm - Ø 11 mm</p>		PC668
MICROMOTOR TKD DEFINITIVE LED			 <p>Spray regulation Swivel Safety Handpiece</p> <p>EXTENSION STRING</p> <p>ITAL GRAY RAL7038</p> <p>1650 mm - Ø 11 mm</p>		PC668SH

# OPEN END SCALER DENTAL HOSES

The dental hoses for Tecnomed Italia dental units are made of silicone; they are Latex Free and comply with the UNI CEI EN ISO 13485 quality system.

The chemically stable gold-plated contacts ensure high electrical conductivity and maximum handpiece performance.

The supply tubes comply with REGULATION (EU) No. 10/2011 concerning plastic materials objects intended to meet food products and the exhaust tubes are resistant to the lubrication oils.

Tecnomed Italia dental hoses meet the strictest medical standards, complying with the essential requirements of the European Directives (93/42 / EEC) 2007/47 / EC on medical devices and 2000/95 / EC RoHs on the restriction of the use of certain specific substances in electrical and electronic equipment.

A complete range of dental hoses:

- Turbines
- Micromotors
- Scalers
- Syringes
- Freely Adaptable Dental Hoses

- ⊕ **High quality silicone sheath**
- ⊕ **Latex free**
- ⊕ **12 months warranty**

## **Technical data:**

Maximum pressure supply/return air: 4.5 bar / 65 psi

Maximum pressure air/water spray: 4 bar /58 psi

Tensile strength: 70 N







# OPEN END CORDONS SCALER

HANDPIECE TYPE	IMAGE	LENGHT / DIAMETER / COLOR	CONNECTIONS	ORDER CODE
EMS®		<p>EXTENSION STRING</p> <p>LIGHT GREY RAL7035</p> <p>L 2000 mm - Ø 7 mm</p>		PC314
EMS®		<p>EXTENSION STRING</p> <p>LIGHT GREY RAL7035</p> <p>L 2000 mm - Ø 7 mm</p>		PC314/B
EMS® O.F.		<p>EXTENSION STRING</p> <p>LIGHT GREY RAL7035</p> <p>L 2000 mm - Ø 8 mm</p>		PC314L

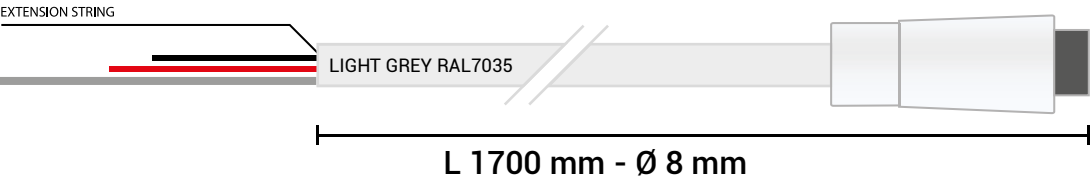
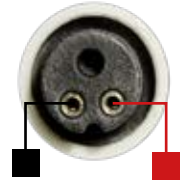
# OPEN END CORDONS SCALER

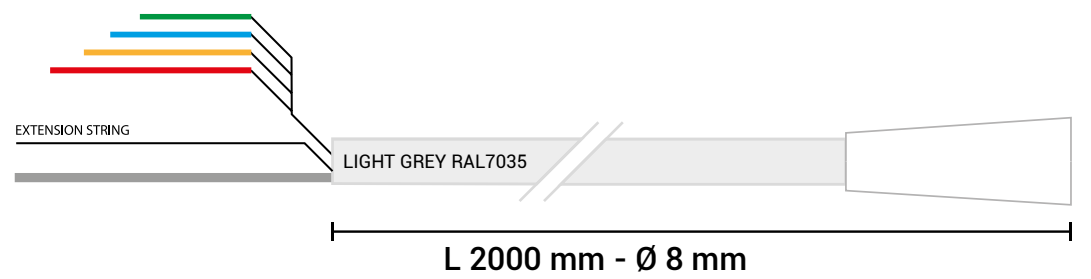
HANDPIECE TYPE	IMAGE	LENGTH / DIAMETER / COLOR	CONNECTIONS	ORDER CODE
EMS® O.F.		<p>EXTENSION STRING</p> <p>LIGHT GREY RAL7035</p> <p>L 1980 mm - Ø 8 mm</p>		PC314LW
EMS® I-PIEZON WHITE COLOR		<p>EXTENSION STRING</p> <p>LIGHT GREY RAL7035</p> <p>L 1850 mm - Ø 8 mm</p>		PC314IPL
SATELEC® NSK VARIOS		<p>EXTENSION STRING</p> <p>LIGHT GREY RAL7035</p> <p>L 2000 mm - Ø 7 mm</p>		PS115

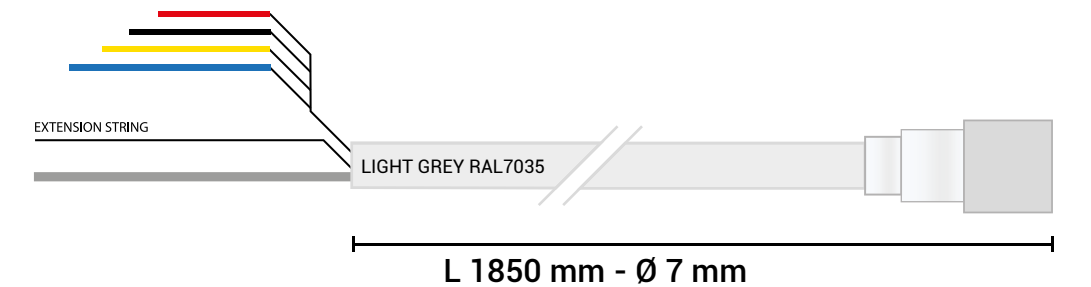
# OPEN END CORDONS SCALER

HANDPIECE TYPE	IMAGE	LENGHT / DIAMETER / COLOR	CONNECTIONS	ORDER CODE
MECTRON®				PS117MN
SATELEC® O.F. ULTRADENT NEWTRON				PS115L
NSK® VARIOS LUX			  with LED 3.5 VDC	PC118N

# KAVO DENTAL HOSES

The dental hoses for Tecnomed Italia dental units are made of silicone; they are Latex Free and comply with the UNI CEI EN ISO 13485 quality system.

The chemically stable gold-plated contacts ensure high electrical conductivity and maximum handpiece performance.

The supply tubes comply with REGULATION (EU) No. 10/2011 concerning plastic materials objects intended to meet food products and the exhaust tubes are resistant to the lubrication oils.

Tecnomed Italia dental hoses meet the strictest medical standards, complying with the essential requirements of the European Directives (93/42 / EEC) 2007/47 / EC on medical devices and 2000/95 / EC RoHs on the restriction of the use of certain specific substances in electrical and electronic equipment.

A complete range of dental hoses:

- Turbines
- Micromotors
- Scalers
- Syringes
- Freely Adaptable Dental Hoses







## Features

- ⊕ High quality silicone sheath.
- ⊕ Latex free.
- ⊕ 12 months warranty



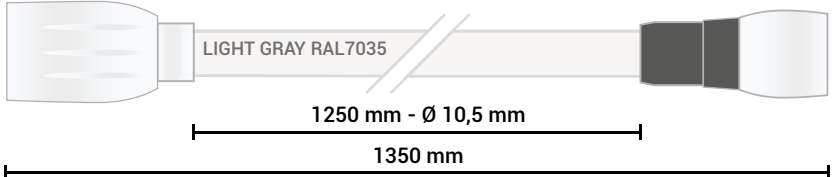

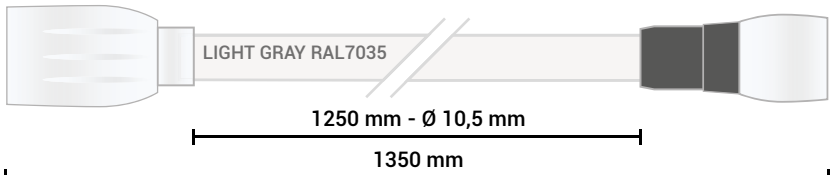

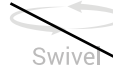
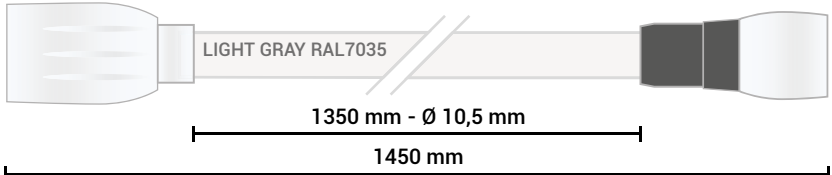



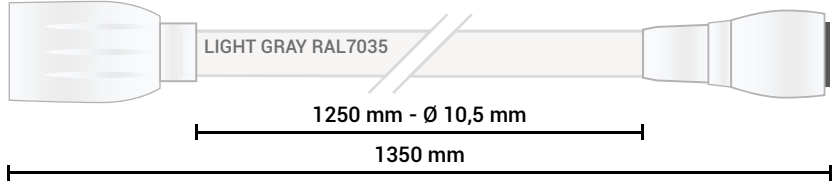

## Technical data

- ⊕ Maximum pressure supply/return air 4,5 bar / 65 psi
- ⊕ Maximum pressure air/water spray 4 bar / 58 psi
- ⊕ Tensile strenght 70N

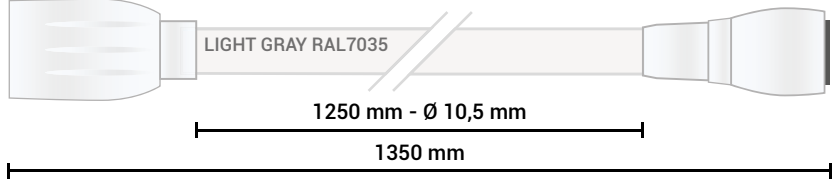

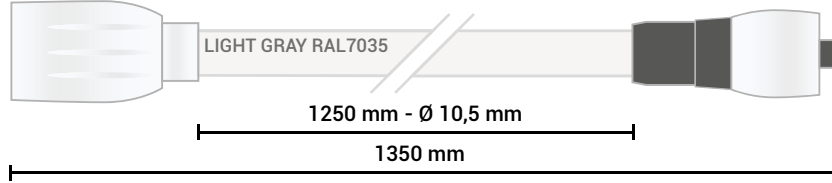

# MICROMOTORS TYPE

HANDPIECE TYPE	DENTAL UNIT MODEL	IMAGE	LENGHT / DIAMETER / COLOR	CONNECTIONS	ORDER CODE
MICROMOTOR K700 K701 K703	1057 1060		<p>JUMPER 3-4</p> <p>Spray regulation  Swivel </p> <p>LIGHT GRAY RAL7035</p> <p>1250 mm - Ø 10,5 mm</p> <p>1350 mm</p> 		PC148KN13
MICROMOTOR K700 K701 K703	1058 1062 1063 1065 1066 1078 1080		<p>JUMPER 1-3-4</p> <p>Spray regulation  Swivel </p> <p>LIGHT GRAY RAL7035</p> <p>1250 mm - Ø 10,5 mm</p> <p>1350 mm</p> 		PC148KN
MICROMOTOR K700 K701 K703	1058 1062 1063 1065 1066 1078 1080		<p>JUMPER 1-3-4</p> <p>Spray regulation  Swivel </p> <p>LIGHT GRAY RAL7035</p> <p>1350 mm - Ø 10,5 mm</p> <p>1450 mm</p> 		PC148KN14

# MICROMOTORS TYPE

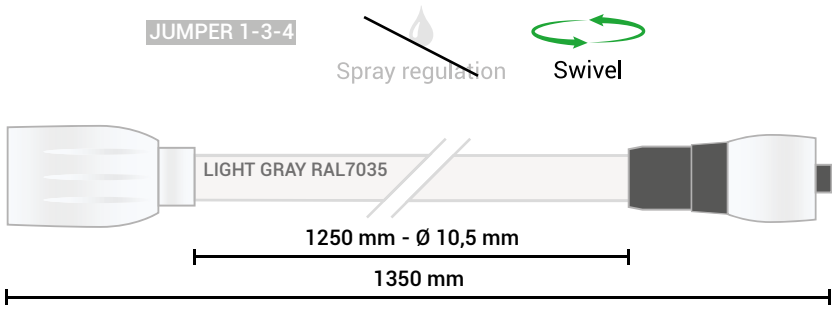
HANDPIECE TYPE	DENTAL UNIT MODEL	IMAGE	LENGHT / DIAMETER / COLOR	CONNECTIONS	ORDER CODE
MICROMOTOR  K700 K701 K703	E30S - E30T E50S - E70S E50TM - E70C E70T - E80C E80T 1058 LIFE		<p>RES. 4,2 KΩ</p> <p>Spray regulation  Swivel </p> <p>LIGHT GRAY RAL7035</p> <p>1250 mm - Ø 10,5 mm</p> <p>1350 mm</p> 		PC148KN5
MICROMOTOR  K700 K701 K703	E30S E30T		<p>RES. 4,2 KΩ</p> <p>Spray regulation  Swivel </p> <p>LIGHT GRAY RAL7035</p> <p>1250 mm - Ø 10,5 mm</p> <p>1350 mm</p> 		PC148KN3
MICROMOTOR  K190 K196 K200 TMI MJ660	1057 1060		<p>JUMPER 3-4</p> <p>Spray regulation  Swivel </p> <p>LIGHT GRAY RAL7035</p> <p>1250 mm - Ø 10,5 mm</p> <p>1350 mm</p> 		PC146KN

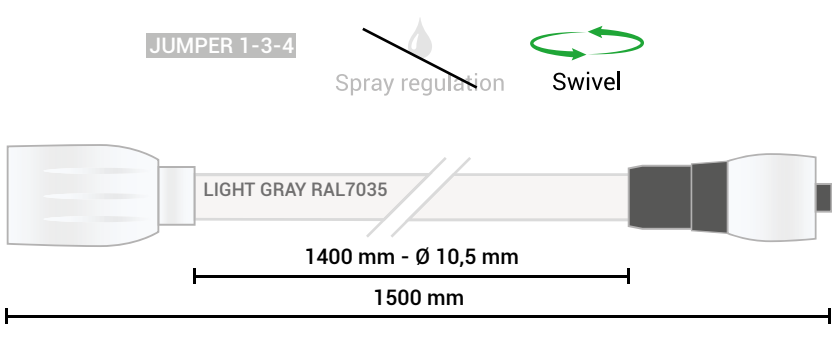

# MICROMOTORS TYPE

HANDPIECE TYPE	DENTAL UNIT MODEL	IMAGE	LENGHT / DIAMETER / COLOR	CONNECTIONS	ORDER CODE
MICROMOTOR K190 K196 K200 TMI MJ660	1058 1062 1063 1065 1066 1080		 <p>JUMPER 1-3-4</p> <p>Spray regulation</p> <p>Swivel</p> <p>LIGHT GRAY RAL7035</p> <p>1250 mm - Ø 10,5 mm</p> <p>1350 mm</p>		PC135KN
MICROMOTOR K190 K196 K200 TMI MJ660	1066 1080		 <p>JUMPER 1-3-4</p> <p>Spray regulation</p> <p>Swivel</p> <p>LIGHT GRAY RAL7035</p> <p>1400 mm - Ø 10,5 mm</p> <p>1500 mm</p>		PC135KNL





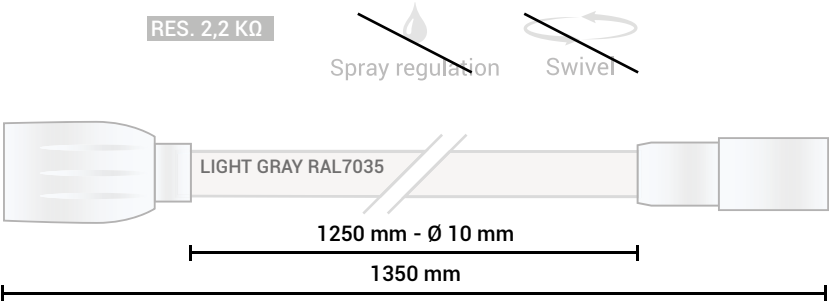

# HIGHSPEED TYPE

HANDPIECE TYPE	DENTAL UNIT MODEL	IMAGE	LENGHT / DIAMETER / COLOR	CONNECTIONS	ORDER CODE
HIGHSPEED HSH	1057 1058 1060 1062 1063 1065 1066 1078 1080		<p>Spray regulation Swivel</p> <p>LIGHT GRAY RAL7035</p> <p>1250 mm - Ø 10 mm</p> <p>1350 mm</p>		PC103KN
HIGHSPEED HSH	E50TM E70C E70T E80C E80T 1058 LIFE		<p>RES. 2,2 KΩ RID SENSOR</p> <p>Spray regulation Swivel</p> <p>LIGHT GRAY RAL7035</p> <p>1250 mm - Ø 10 mm</p> <p>1350 mm</p>		PC104KN
HIGHSPEED HSH	E50T E70T E80T 1058 LIFE  PENDED		<p>RES. 2,2 KΩ RID SENSOR</p> <p>Spray regulation Swivel</p> <p>LIGHT GRAY RAL7035</p> <p>1550 mm - Ø 10 mm</p> <p>1650 mm</p>		PC104KN14

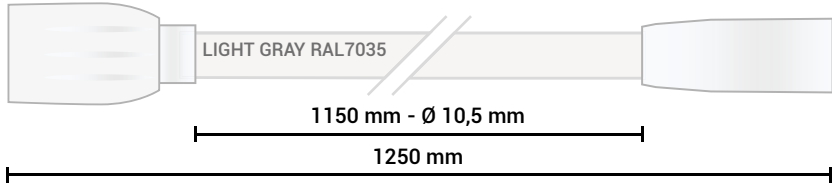

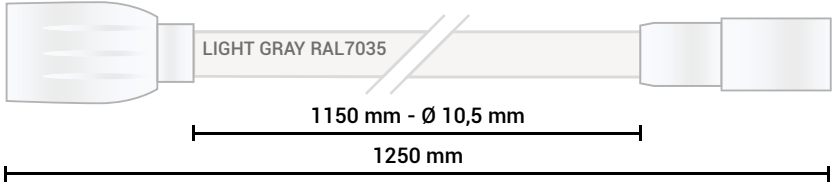

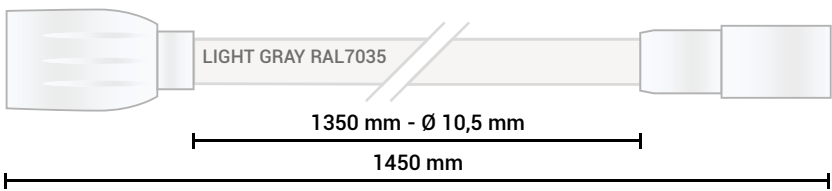

# HIGHSPEED TYPE

HANDPIECE TYPE	DENTAL UNIT MODEL	IMAGE	LENGHT / DIAMETER / COLOR	CONNECTIONS	ORDER CODE
HIGHSPEED  HSH	E30S E30T E50S E70S		 <p>RES. 2,2 KΩ</p> <p>Spray regulation Swivel</p> <p>LIGHT GRAY RAL7035</p> <p>1250 mm - Ø 10 mm</p> <p>1350 mm</p>		PC105KN

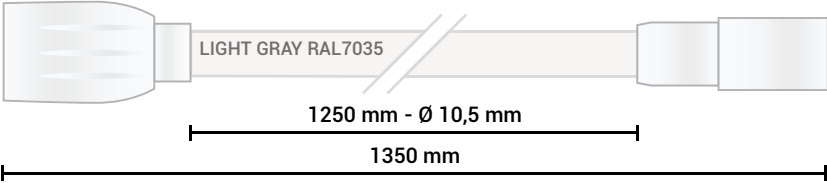
# SYRINGE TYPE

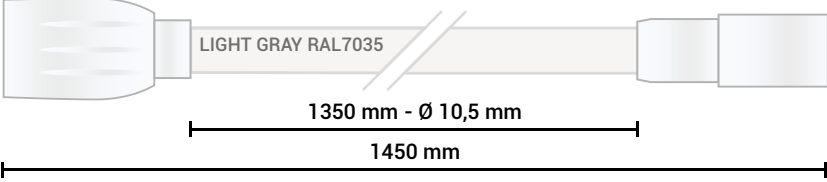
HANDPIECE TYPE	DENTAL UNIT MODEL	IMAGE	LENGHT / DIAMETER / COLOR	CONNECTIONS	ORDER CODE
<p>SYRINGE</p> <p>3F KAVO (07730500)</p>	<p>1058</p> <p>1062</p> <p>1063</p> <p>1065</p> <p>1066</p> <p>1080</p>		 <p>LIGHT GRAY RAL7035</p> <p>1150 mm - Ø 10,5 mm</p> <p>1250 mm</p>		<p>PC168KE</p>
<p>SYRINGE</p> <p>4F KAVO (07730000)</p>	<p>1058</p> <p>1062</p> <p>1063</p> <p>1065</p> <p>1066</p> <p>1080</p>		 <p>LIGHT GRAY RAL7035</p> <p>1150 mm - Ø 10,5 mm</p> <p>1250 mm</p>		<p>PC168KN</p>
<p>SYRINGE</p> <p>4F KAVO (07730000)</p>	<p>1066</p> <p>1080</p>		 <p>LIGHT GRAY RAL7035</p> <p>1350 mm - Ø 10,5 mm</p> <p>1450 mm</p>		<p>PC168KNL</p>

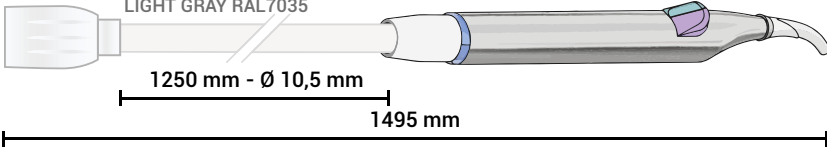









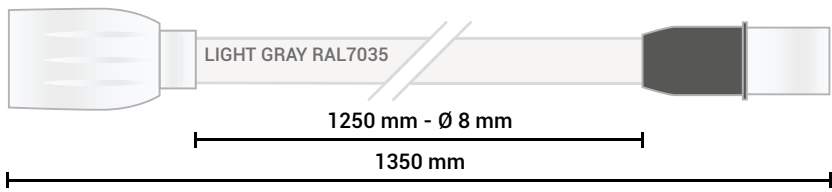

# SYRINGE TYPE

HANDPIECE TYPE	DENTAL UNIT MODEL	IMAGE	LENGHT / DIAMETER / COLOR	CONNECTIONS	ORDER CODE
<p>SYRINGE</p> <p>4F KAVO (07730000)</p>	<p>E50TM E70C E70T E80C E80T 1058 LIFE TM</p>		<p>RES. 750 Ω</p> <p>LIGHT GRAY RAL7035</p> <p>1250 mm - Ø 10,5 mm</p> <p>1350 mm</p> 		<p>PC168KV</p>
<p>SYRINGE</p> <p>4F KAVO (07730000)</p>	<p>E50S E70S E70T E80T</p>		<p>RES. 750 Ω</p> <p>LIGHT GRAY RAL7035</p> <p>1350 mm - Ø 10,5 mm</p> <p>1450 mm</p> 		<p>PC168KVL</p>
<p>SYRINGE</p> <p>6F LUZZANI O.F. MINIBRIGHT INOX</p>	<p>E50S E70S E70T E80T</p>		<p>RES. 750 Ω</p> <p>LIGHT GRAY RAL7035</p> <p>1250 mm - Ø 10,5 mm</p> <p>1495 mm</p> 		<p>PC168KMB</p>

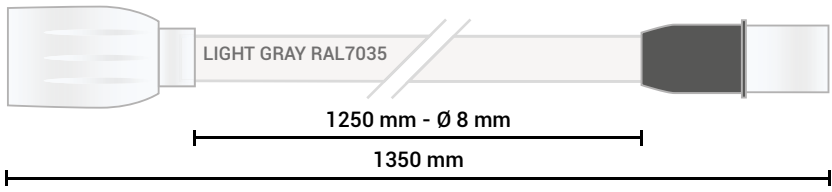
# SYRINGE TYPE

HANDPIECE TYPE	DENTAL UNIT MODEL	IMAGE	LENGHT / DIAMETER / COLOR	CONNECTIONS	ORDER CODE
<p>SYRINGE</p> <p>LUZZANI 3F MINILIGHT INOX</p>	<p>1057 1058 1060 1062 1063 1065 1066 1078 1080</p>		<p>LIGHT GRAY RAL7035 1200 mm - Ø 10,5 mm 1445 mm</p>		PC179KN
<p>SYRINGE</p> <p>LUZZANI 3F MINILIGHT INOX</p>	<p>E50TM E70C E70T E80C E80T 1058 LIFE TM</p>		<p>RES. 750 Ω LIGHT GRAY RAL7035 1250 mm - Ø 10,5 mm 1495 mm</p>		PC179KN2
<p>SYRINGE</p> <p>LUZZANI 3F MINILIGHT INOX</p>	<p>E50S E70S E70T E80T</p>		<p>RES. 750 Ω LIGHT GRAY RAL7035 1500 mm - Ø 10,5 mm 1745 mm</p>		PC179KN2L

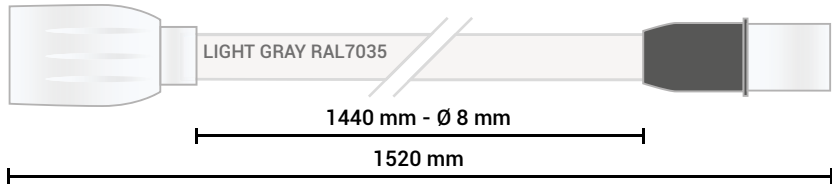
# SCALER TYPE

HANDPIECE TYPE	DENTAL UNIT MODEL	IMAGE	LENGHT / DIAMETER / COLOR	CONNECTIONS	ORDER CODE
SCALER* PIEZOLED EMS O. F.	E50S E50TM E70C E70S E70T E80C E80T 1058 LIFE S 1058 LIFE TM 1058LIFE CART		<p>RES. 1,3 KΩ RID SENSOR</p> <p>Spray regulation  Swivel </p> <p>LIGHT GRAY RAL7035</p> <p>1250 mm - Ø 8 mm</p> <p>1350 mm</p> 		PC151KRWG
SCALER EMS O. F.	E30S E30T		<p>RES. 1,3 KΩ</p> <p>Spray regulation  Swivel </p> <p>LIGHT GRAY RAL7035</p> <p>1250 mm - Ø 8 mm</p> <p>1350 mm</p> 		PC151KE
SCALER EMS O. F.	E30S E30T		<p>RES. 1,3 KΩ</p> <p>Spray regulation  Swivel </p> <p>LIGHT GRAY RAL7035</p> <p>1440 mm - Ø 8 mm</p> <p>1520 mm</p> 		PC151KEL

# SCALER TYPE

HANDPIECE TYPE	DENTAL UNIT MODEL	IMAGE	LENGHT / DIAMETER / COLOR	CONNECTIONS	ORDER CODE
SCALER EMS O. F.	E50S E50TM E70C E70S E70T E80C E80T 1058 LIFE S 1058 LIFE TM 1058LIFE CART		<p>RES. 1,3 KΩ RID SENSOR</p> <p>Spray regulation </p> <p>Swivel </p> <p>LIGHT GRAY RAL7035</p> <p>1250 mm - Ø 8 mm</p> <p>1350 mm</p>		PC151KEW
SCALER EMS O. F.	1058 1062 1063 1065 1066 1080		<p>JUMPER 1-3</p> <p>Spray regulation </p> <p>Swivel </p> <p>LIGHT GRAY RAL7035</p> <p>1250 mm - Ø 8 mm</p> <p>1350 mm</p>		PC151KEWG

# SCALER TYPE

HANDPIECE TYPE	DENTAL UNIT MODEL	IMAGE	LENGHT / DIAMETER / COLOR	CONNECTIONS	ORDER CODE
SCALER * EMS O. F.  KAVO PIEZOLED	E50S E50TM E70C E70S E70T E80C E80T 1058		<p>RES. 1,3 KΩ</p> <p>JUMPER 1-3</p> <p>Spray regulation </p> <p>Swivel </p> <p>LIGHT GRAY RAL7035</p> <p>1255 mm - Ø 8 mm</p> <p>1350 mm</p>	<p>REVERSE POLARITY</p>	PC152KEWG
			<p>LIGHT GRAY RAL7035</p> <p>1255 mm - Ø 8 mm</p> <p>1350 mm</p>		PC152KEWGI
SCALER * EMS O. F.  KAVO PIEZOLED	E30S E30T		<p>RES. 1,3 KΩ</p> <p>Spray regulation </p> <p>Swivel </p> <p>LIGHT GRAY RAL7035</p> <p>1250 mm - Ø 8 mm</p> <p>1350 mm</p>		PC153KRWG

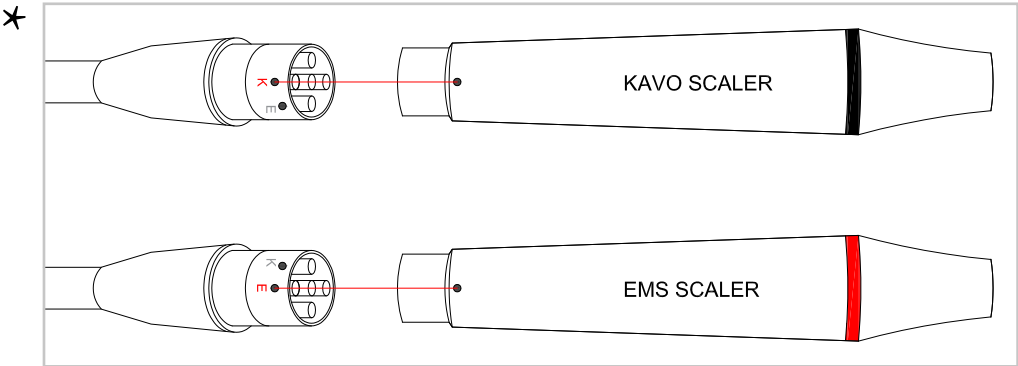

# PLANMECA DENTAL HOSES

The dental hoses for Tecnomed Italia dental units are made of silicone; they are Latex Free and comply with the UNI CEI EN ISO 13485 quality system.

The chemically stable gold-plated contacts ensure high electrical conductivity and maximum handpiece performance.

The supply tubes comply with REGULATION (EU) No. 10/2011 concerning plastic materials objects intended to meet food products and the exhaust tubes are resistant to the lubrication oils.

Tecnomed Italia dental hoses meet the strictest medical standards, complying with the essential requirements of the European Directives (93/42 / EEC) 2007/47 / EC on medical devices and 2000/95 / EC RoHs on the restriction of the use of certain specific substances in electrical and electronic equipment.

A complete range of dental hoses:

- Turbines
- Micromotors
- Scalers
- Syringes
- Freely Adaptable Dental Hoses







## Features

- ⊕ High quality silicone sheath.
- ⊕ Latex free.
- ⊕ 12 months warranty

## Technical data

- ⊕ Maximum pressure supply/return air 4,5 bar / 65 psi
- ⊕ Maximum pressure air/water spray 4 bar / 58 psi
- ⊕ Tensile strenght 70N





# MICROMOTORS TYPE

HANDPIECE TYPE	DENTAL UNIT MODEL	IMAGE	LENGHT / DIAMETER / COLOR	CONNECTIONS	ORDER CODE
MICROMOTOR MC3			<p>RES. 83 Ω</p> <p>Spray regulation Swivel</p> <p>LIGHT GRAY RAL7035</p> <p>890 mm - Ø 10 mm</p> <p>980 mm</p>		PC812P
MICROMOTOR MC3			<p>RES. 83 Ω</p> <p>Spray regulation Swivel</p> <p>LIGHT GRAY RAL7035</p> <p>925 mm - Ø 10 mm</p> <p>1015 mm</p>		PC812PL
MICROMOTOR MC3			<p>RES. 825 Ω</p> <p>Spray regulation Swivel</p> <p>LIGHT GRAY RAL7035</p> <p>890 mm - Ø 10 mm</p> <p>980 mm</p>		PC812P2



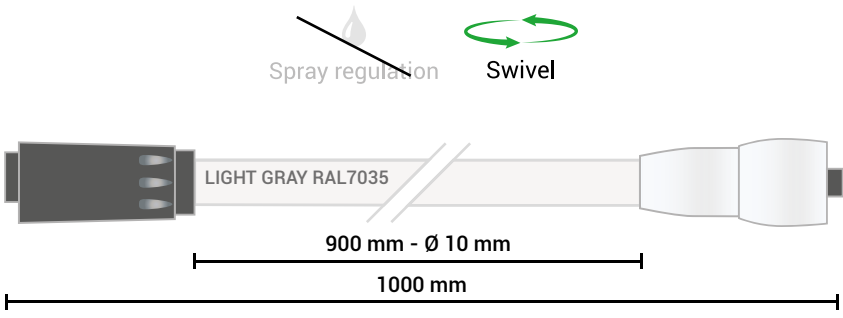



# MICROMOTORS TYPE

HANDPIECE TYPE	DENTAL UNIT MODEL	IMAGE	LENGHT / DIAMETER / COLOR	CONNECTIONS	ORDER CODE
MICROMOTOR MC3			<p>RES. 825 Ω</p> <p>Spray regulation Swivel</p> <p>LIGHT GRAY RAL7035</p> <p>925 mm - Ø 10 mm</p> <p>1015 mm</p>		PC812PL2
MICROMOTOR K190 K196 K200			<p>RES. 267 Ω</p> <p>Spray regulation Swivel</p> <p>LIGHT GRAY RAL7035</p> <p>925 mm - Ø 10 mm</p> <p>1015 mm</p>		PC823PL
MICROMOTOR K190 K196 K200			<p>RES. 267 Ω</p> <p>Spray regulation Swivel</p> <p>LIGHT GRAY RAL7035</p> <p>900 mm - Ø 10 mm</p> <p>1000 mm</p>		PC823P





# MICROMOTORS TYPE

HANDPIECE TYPE	DENTAL UNIT MODEL	IMAGE	LENGHT / DIAMETER / COLOR	CONNECTIONS	ORDER CODE
<p>MICROMOTOR</p> <p>K190 K196 K200</p>			 <p>Spray regulation</p> <p>Swivel</p> <p>LIGHT GRAY RAL7035</p> <p>900 mm - Ø 10 mm</p> <p>1000 mm</p>		<p>PC823P/2</p>
<p>MICROMOTOR</p> <p>MINETTO</p>			 <p>Spray regulation</p> <p>Swivel</p> <p>EXTENSION STRING</p> <p>LIGHT GRAY RAL7035</p> <p>1800 mm - Ø 10 mm</p> <p><a href="https://vimeo.com/480812578">https://vimeo.com/480812578</a></p>		<p>PC888P</p>



# HIGHSPEED TYPE

HANDPIECE TYPE	DENTAL UNIT MODEL	IMAGE	LENGHT / DIAMETER / COLOR	CONNECTIONS	ORDER CODE
HIGHSPEED HSH			<p>RES. 825 Ω</p> <p>Spray regulation Swivel</p> <p>LIGHT GRAY RAL7035</p> <p>925 mm - Ø 10 mm</p> <p>1015 mm</p>		PC801P
HIGHSPEED HSH			<p>RES. 430 Ω</p> <p>Spray regulation Swivel</p> <p>LIGHT GRAY RAL7035</p> <p>825 mm - Ø 10 mm</p> <p>915 mm</p>		PC802P
HIGHSPEED HSH			<p>RES. 430 Ω</p> <p>Spray regulation Swivel</p> <p>LIGHT GRAY RAL7035</p> <p>840 mm - Ø 10 mm</p> <p>930 mm</p>		PC802PL

# HIGHSPEED TYPE

HANDPIECE TYPE	DENTAL UNIT MODEL	IMAGE	LENGHT / DIAMETER / COLOR	CONNECTIONS	ORDER CODE
HIGHSPEED HSH			<p>RES. 430 Ω</p> <p>Spray regulation Swivel</p> <p>LIGHT GRAY RAL7035</p> <p>925 mm - Ø 10 mm</p> <p>1015 mm</p>		PC803PVL
HIGHSPEED HSH			<p>RES. 560 Ω</p> <p>Spray regulation Swivel</p> <p>LIGHT GRAY RAL7035</p> <p>825 mm - Ø 10 mm</p> <p>915 mm</p>		PC803P

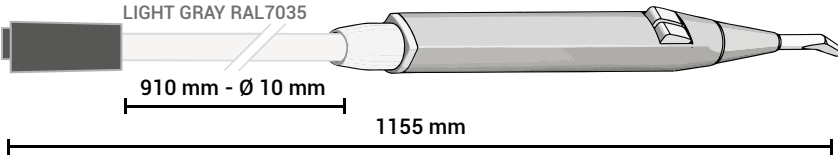

# SYRINGE TYPE

HANDPIECE TYPE	DENTAL UNIT MODEL	IMAGE	LENGHT / DIAMETER / COLOR	CONNECTIONS	ORDER CODE
<p>SYRINGE LUZZANI 3F</p>			<p>RES. 1,78 KΩ</p>  <p>LIGHT GRAY RAL7035</p> <p>910 mm - Ø 10 mm</p> <p>1155 mm</p>		<p>PC845P</p>

# SCALER TYPE

HANDPIECE TYPE	DENTAL UNIT MODEL	IMAGE	LENGHT / DIAMETER / COLOR	CONNECTIONS	ORDER CODE
SCALER EMS			<p>RES. 1,33 KΩ</p> <p>Spray regulation Swivel</p> <p>LIGHT GRAY RAL7035</p> <p>930 mm - Ø 7 mm</p> <p>1020 mm</p>		PC834P
SCALER EMS O. F.			<p>RES. 1,33 KΩ</p> <p>Spray regulation Swivel</p> <p>LIGHT GRAY RAL7035</p> <p>930 mm - Ø 8 mm</p> <p>1020 mm</p>		PC834PL
SCALER SATELEC O. F.			<p>RES. 1,2 KΩ</p> <p>Spray regulation Swivel</p> <p>LIGHT GRAY RAL7035</p> <p>930 mm - Ø 8 mm</p> <p>1020 mm</p>		PC834PSL

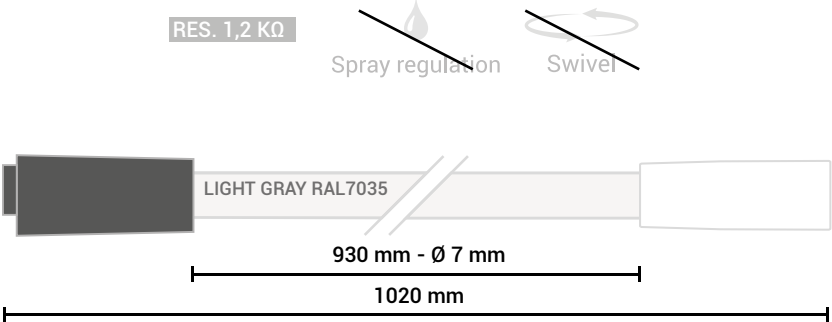
# SCALER TYPE

HANDPIECE TYPE	DENTAL UNIT MODEL	IMAGE	LENGTH / DIAMETER / COLOR	CONNECTIONS	ORDER CODE
SCALER SATELEC			<p>RES. 1,2 KΩ</p> <p>Spray regulation</p> <p>Swivel</p> <p>LIGHT GRAY RAL7035</p> <p>930 mm - Ø 7 mm</p> <p>1020 mm</p> 		PC834PS

# SIRONA DENTAL HOSES

The dental hoses for Tecnomed Italia dental units are made of silicone; they are Latex Free and comply with the UNI CEI EN ISO 13485 quality system.

The chemically stable gold-plated contacts ensure high electrical conductivity and maximum handpiece performance.

The supply tubes comply with REGULATION (EU) No. 10/2011 concerning plastic materials objects intended to meet food products and the exhaust tubes are resistant to the lubrication oils.

Tecnomed Italia dental hoses meet the strictest medical standards, complying with the essential requirements of the European Directives (93/42 / EEC) 2007/47 / EC on medical devices and 2000/95 / EC RoHs on the restriction of the use of certain specific substances in electrical and electronic equipment.

A complete range of dental hoses:

- Turbines
- Micromotors
- Scalers
- Syringes
- Freely Adaptable Dental Hoses







## Features

- ⊕ High quality silicone sheath.
- ⊕ Latex free.
- ⊕ 12 months warranty

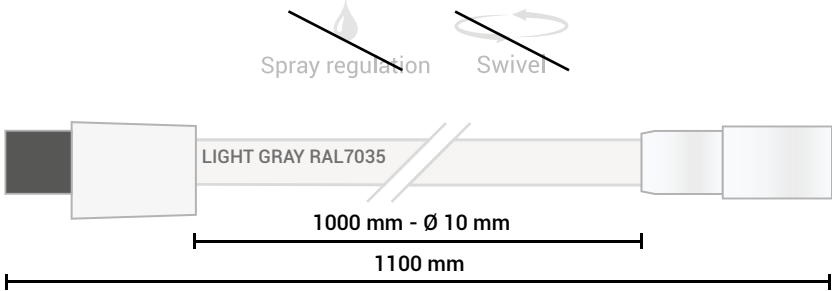

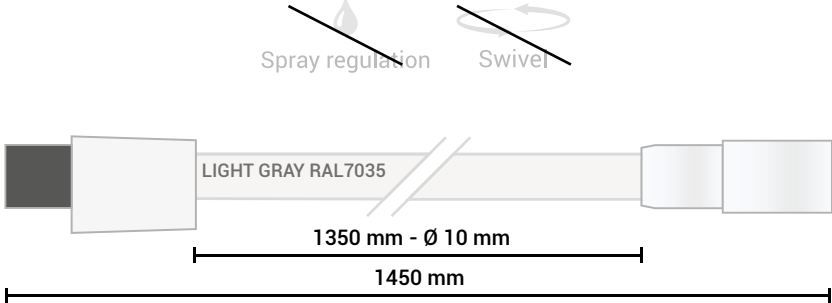

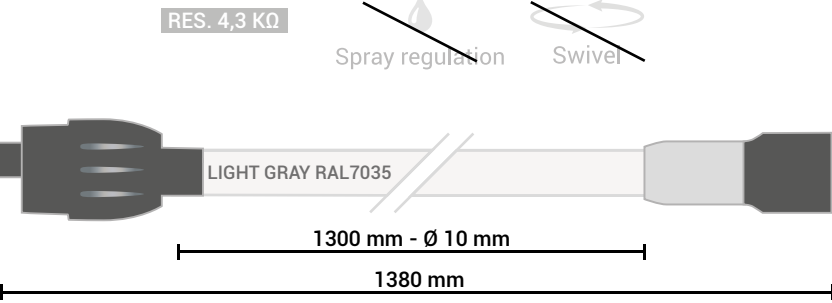

## Technical data

- ⊕ Maximum pressure supply/return air 4,5 bar / 65 psi
- ⊕ Maximum pressure air/water spray 4 bar / 58 psi
- ⊕ Tensile strenght 70N





# MICROMOTORS TYPE

HANDPIECE TYPE	DENTAL UNIT MODEL	IMAGE	LENGHT / DIAMETER / COLOR	CONNECTIONS	ORDER CODE
MICROMOTOR MC3 M40	C6 E3 C3 C3 +				PC233S
MICROMOTOR MC3 M40	C1 C1 + C2 C2 + C4 C4 + C5 + M1 +				PC233SL
MICROMOTOR EL1	C1 C1 + C2 C2 + C4 C4 + C5 + M1 +				PC224C4N



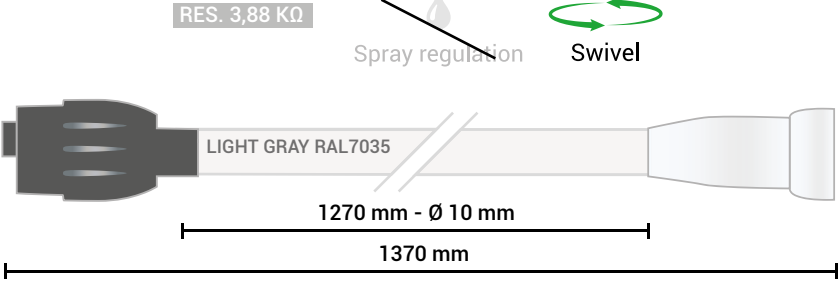

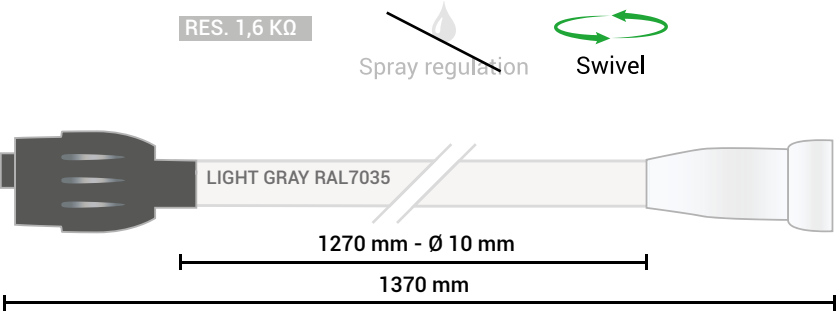

# MICROMOTORS TYPE

HANDPIECE TYPE	DENTAL UNIT MODEL	IMAGE	LENGHT / DIAMETER / COLOR	CONNECTIONS	ORDER CODE
MICROMOTOR EL1	C3 C3 + C6		<p>RES. 4,3 KΩ</p> <p>Spray regulation Swivel</p> <p>LIGHT GRAY RAL7035</p> <p>1000 mm - Ø 10 mm</p> <p>1080 mm</p>		PC224SN
MICROMOTOR EL1	C8 C8 + PRO FEEL		<p>RES. 30,4 KΩ</p> <p>Spray regulation Swivel</p> <p>LIGHT GRAY RAL7035</p> <p>1350 mm - Ø 10 mm</p> <p>1450 mm</p>		PC224S/2N
MICROMOTOR BL ISO	TENEO		<p>RES. 2 KΩ</p> <p>Spray regulation Swivel</p> <p>LIGHT GRAY RAL7035</p> <p>1270 mm - Ø 10 mm</p> <p>1370 mm</p>		PC235SBI

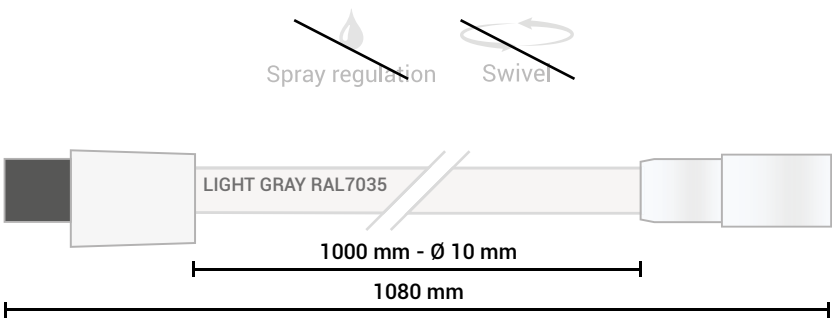

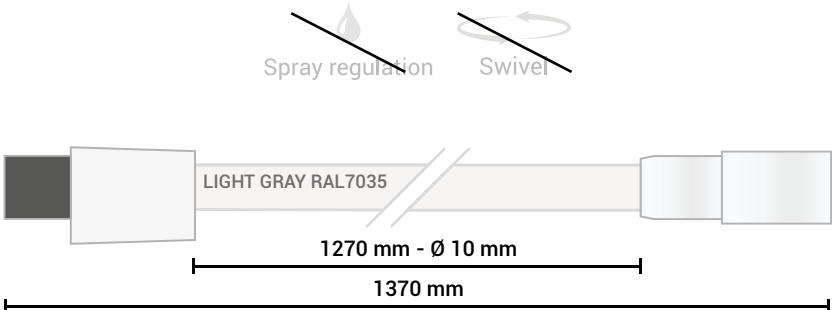

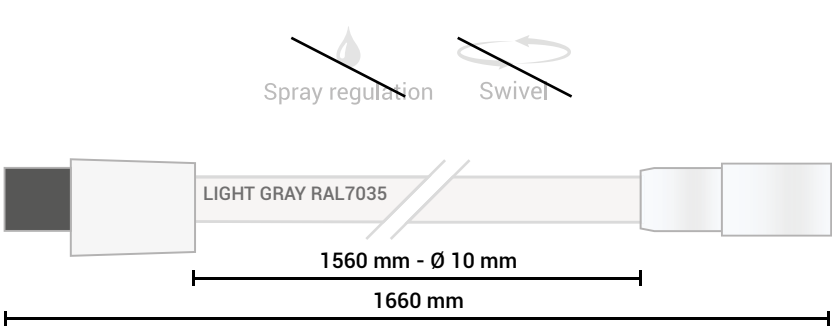
# MICROMOTORS TYPE

HANDPIECE TYPE	DENTAL UNIT MODEL	IMAGE	LENGTH / DIAMETER / COLOR	CONNECTIONS	ORDER CODE
MICROMOTOR BL ISO C	TENEO SINIUS INTEGO INTEGO PRO		<p>RES. 3,88 KΩ</p> <p>Spray regulation</p> <p>Swivel</p> <p>LIGHT GRAY RAL7035</p> <p>1270 mm - Ø 10 mm</p> <p>1370 mm</p> 		PC235SBIC
MICROMOTOR BL	TENEO		<p>RES. 1,6 KΩ</p> <p>Spray regulation</p> <p>Swivel</p> <p>LIGHT GRAY RAL7035</p> <p>1270 mm - Ø 10 mm</p> <p>1370 mm</p> 		PC235SBL

# HIGHSPEED TYPE

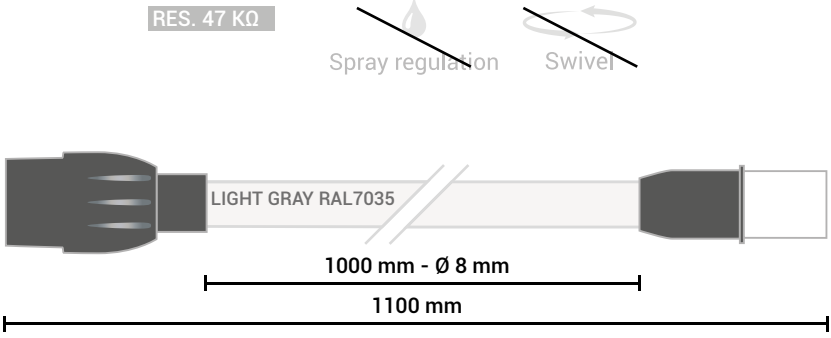
HANDPIECE TYPE	DENTAL UNIT MODEL	IMAGE	LENGHT / DIAMETER / COLOR	CONNECTIONS	ORDER CODE
HIGHSPEED HSH	C6 E3 C3 C3 +		 <p>Spray regulation Swivel</p> <p>LIGHT GRAY RAL7035</p> <p>1000 mm - Ø 10 mm</p> <p>1080 mm</p>		PC204SN
HIGHSPEED HSH	A1, A2, A4, A5, AC, C1, C1 +, C2, C2 +, C4, C4 +, C5 +, E1, E2, E4, E5, EC, M1, C8/+, PRO FEEL+, TENEO, SINIUS, INTEGO, INTEGO PRO		 <p>Spray regulation Swivel</p> <p>LIGHT GRAY RAL7035</p> <p>1270 mm - Ø 10 mm</p> <p>1370 mm</p>		PC204S/2N
HIGHSPEED HSH	A1, A2, A4, A5, AC, C1, C1 +, C2, C2 +, C4, C4 +, C5 +, E1, E2, E4, E5, EC, M1, M1 96, M1 +, TENEO, SINIUS, INTEGO, INTEGO PRO		 <p>Spray regulation Swivel</p> <p>LIGHT GRAY RAL7035</p> <p>1560 mm - Ø 10 mm</p> <p>1660 mm</p>		PC204S/2L

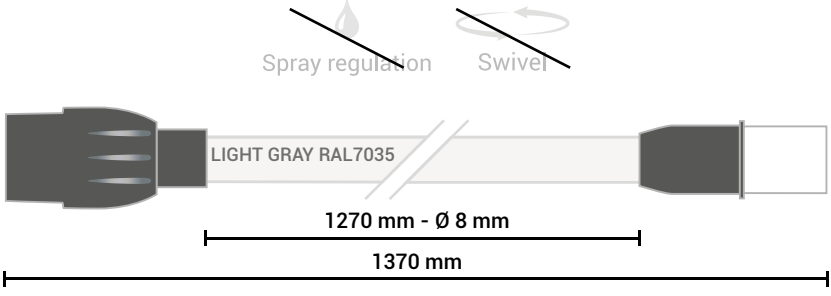
# SCALER TYPE

HANDPIECE TYPE	DENTAL UNIT MODEL	IMAGE	LENGHT / DIAMETER / COLOR	CONNECTIONS	ORDER CODE
SCALER EMS O. F.	C3 C3+ C6		<p>RES. 47 KΩ</p> <p>Spray regulation Swivel</p>  <p>LIGHT GRAY RAL7035</p> <p>1000 mm - Ø 8 mm</p> <p>1100 mm</p>		PC237SEC
SCALER EMS O. F.	C8+ PRO FEEL + INTEGO INTEGO PRO		<p>Spray regulation Swivel</p>  <p>LIGHT GRAY RAL7035</p> <p>1270 mm - Ø 8 mm</p> <p>1370 mm</p>		PC237SENW